



Connectors



CE



GO GREEN
AND
SAVE GREEN

Company Introduction

AQL Technology Limited is a fast growing company whose primary focus is to deliver the latest technology in lighting to our customers. Beside of the super products, we also provide them with perfect solution and creative idea according to their requirements and expectation on the lighting environment.



Our products are suitable for all areas including outdoor and indoor lighting/decorating, commercial lighting/decorating, residential lighting. Our work and service start from Western Europe to Saudi Arabia, and expanding to all over the world.

AQL is engaged in all kinds of newly coming lighting products. At mean time, we are also providing power supply, controllers,

connectors etc. which are essential in lighting system. This is creating a convenient one-stop shopping center for our customers.

We are devoted to providing the best products and service at the lowest cost. The tenet of our business is to achieve a mutual benefit together with our customers. So trust us, you can be sure of a win-win prospect.

You have individual demands for your project. We have the most suitable solution. Whether it's a combination of energy-efficiency, longlife, free of toxic substances and low maintenance



or all of those combined. Thanks to our comprehensive support you will not only reduce the energy requirements of your installation, but also your own work-load. We are at your side and work in close cooperation with you in all phases of the implementation of sustainable, efficient state-of-the-art projects, and support you in your decisions.

At the same time, we are also fully aware of our responsibility as a globally active concern, which is why a conscientious approach to people, materials and goods is deeply rooted in our corporate culture. Ecolution is synonymous with our complete strategy of sustainability; a strategy, moreover, that permeates all sectors of our company like a 'green thread'. With us you will find a partner that observes and implements its corporate responsibility to society and the environment.



The right partners make all the difference. Adherence to all applicable national and international legislation and directive, in addition to all existing internal regulations is a matter of course. We have also fixed our corporate values in an internal code of conduct. Contractually we demand adherence to the same stringent constraints from our suppliers as well. We maintain a management system for the implementation of these corporate policies that also integrates our business partners

Certificates



7.6mm Mini HVL760 Connector System

7.6mm Mini HVL760 Steck Systeme

250V/2.5A 2pole high voltage connector system for luminaires

- The 7.6mm MiniHVL760 connector system is designed according the IEC60320 standard for lighting industry applications. Applicable in power connection and coupling between lamps such as lighting wiring in offices, kitchen, bathroom, shop and household furniture, display cabinets and mountable lighting.
- 7.6mm outer diameter of mini plug to fit into 8mm furniture holes
- Connection: max. 2.5A, 250V AC
- Cable: VDE H03VVH2-F 2x0.75mm²

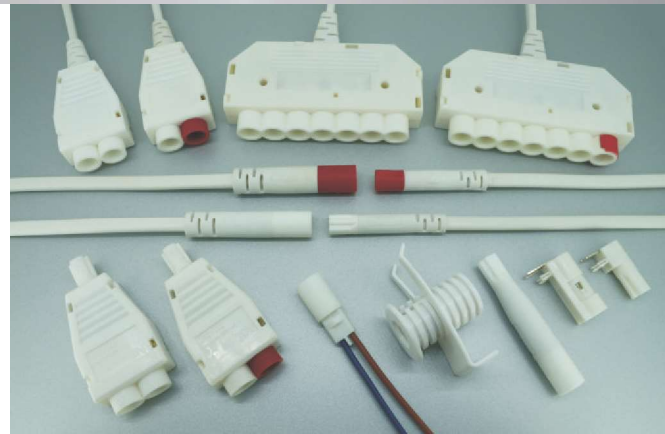

Mini HVL 760

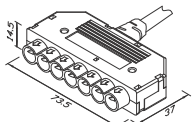
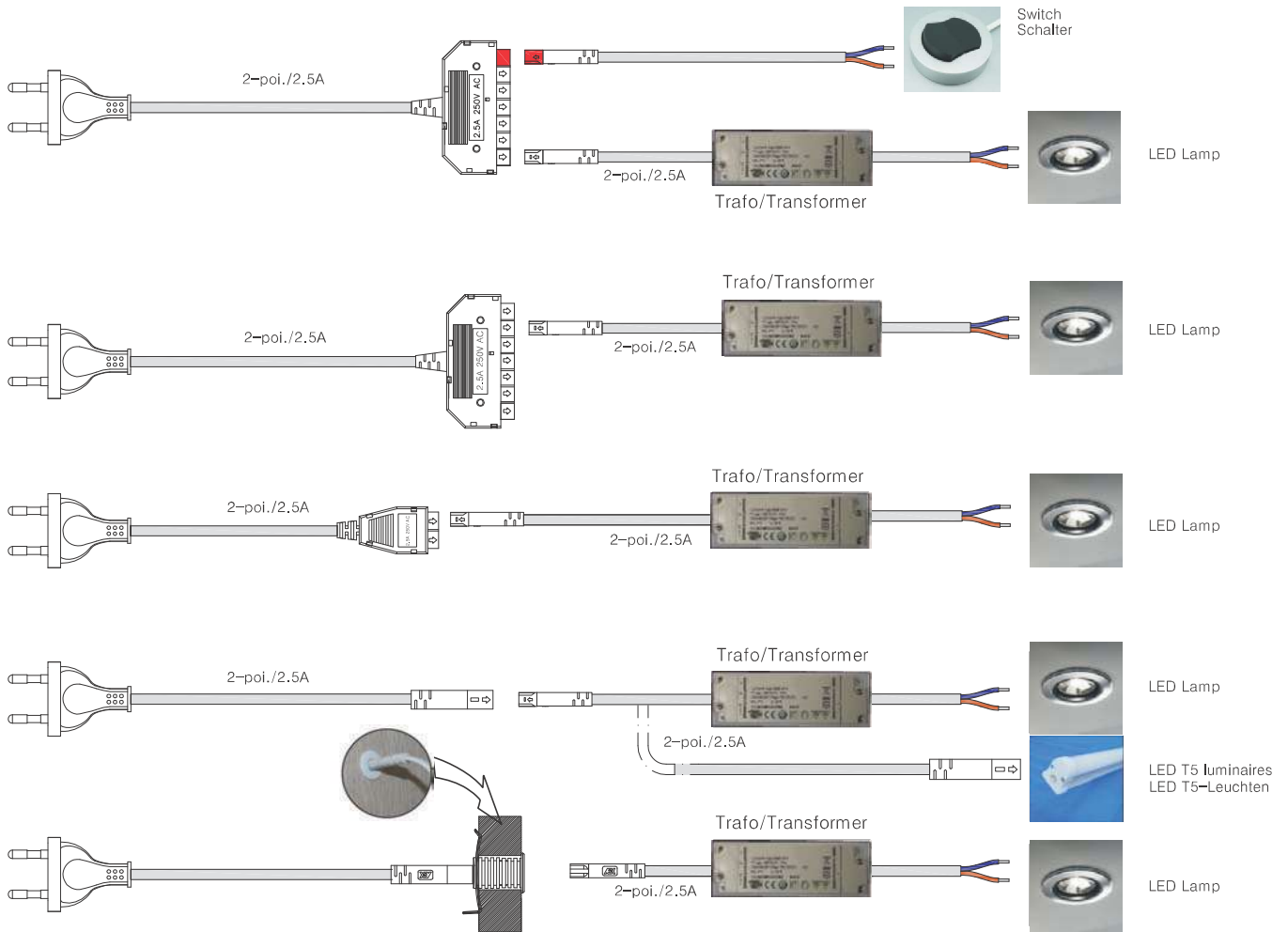

6-way distributor (1 way closed)
6-fach verteiler (1fach geschlossen)
Art No: 250D6

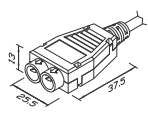

2-way distributor
2-fach verteiler
Art No: 250D2

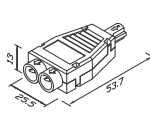

Y-distributor
Y-Verteiler
Art No: 250YD2

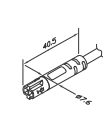

Mini male plug
M in stecker
Art No: 250MP

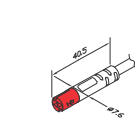

Red mini male plug
Rot m in stecker
Art No: 250SMP

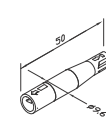

Direct connector
Direktverbinder
Art No: 250FM

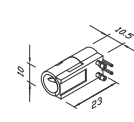

PCB mounting socket
Art No: 250FR

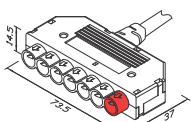

6-way distributor+switch
6-fach verteiler+schalter
Art No: 250D7

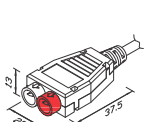

distributor+switch
1-fach verteiler+schalter
Art No: 250D2

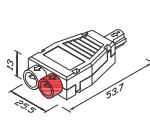

Y-distributor
Y-Verteiler
Art No: 250YD2

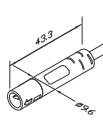

Mini female socket
M in buchse
Art No: 250FS

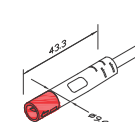

Red mini female socket
Rot m in buchse
Art No: 250SFS

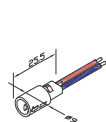

Mini female socket
M in buchse
Art No: 250FV

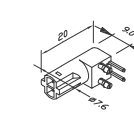



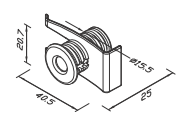





PCB mounting plug
Art No: 250MR



Build-in socket
Einbau-buchse
Art No: 760BI

250V 2.5A - MiniHVL760 connector system

7.6mm Diameter

PHOTO	Art No.	Description
	250MP	Supply Lead <ul style="list-style-type: none"> mini male plug 2.5A/250V AC end tin H03VVH2-F 2x0.75mm² white white
	250FS	Supply Lead <ul style="list-style-type: none"> mini female socket 2.5A/250V AC terminal ends H03VVH2-F 2x0.75mm² white white
	250FME	Extension Lead <ul style="list-style-type: none"> mini male plug mini female socket 2.5A/250V AC H03VVH2-F 2x0.75mm² white white
	250SMP	Coded Supply Lead <ul style="list-style-type: none"> mini male plug for connecting switch 2.5A/250V AC end tin H03VVH2-F 2x0.75mm² white red
	250SFS	Coded Supply Lead <ul style="list-style-type: none"> mini female socket for connecting switch terminal ends 2.5A/250V AC H03VVH2-F 2x0.75mm² white red
	250SMP + 250SFS	Coded Extension Lead <ul style="list-style-type: none"> mini male plug for connecting switch mini female socket 2.5A/250V AC H03VVH2-F 2x0.75mm² white red
	Euro-M+250FS	Supply Lead <ul style="list-style-type: none"> mini female socket euro plug 2.5A/250V AC H03VVH2-F 2x0.75mm² white white
	Euro-F+250MP	Supply Lead <ul style="list-style-type: none"> mini male plug euro socket 2.5A/250V AC H03VVH2-F 2x0.75mm² white white

Mini HVL 760

250V 2.5A - MiniHVL760 connector system

7.6mm Diameter

PHOTO

Art No.

Description



Euro-M+250D7

- Supply Lead/6-way distributor+switch**
- 6-way distributor+switch(red hole=switch)
 - euro plug
 - 2.5A/250V AC
 - H03VVH2-F 2x0.75mm² white
 - white



Euro-M+250D6

- Supply Lead/6-way distributor**
- 6-way distributor(1way closed)
 - euro plug
 - 2.5A/250V AC
 - H03VVH2-F 2x0.75mm² white
 - white



Euro-M+250D2

- Supply Lead/2-way distributor**
- 2-way distributor
 - euro plug
 - 2.5A/250V AC
 - H03VVH2-F 2x0.75mm² white
 - white



Euro-M+250D2

- Supply Lead/2-way distributor**
- 1-way distributor+switch(red hole=switch)
 - euro plug
 - 2.5A/250V AC
 - H03VVH2-F 2x0.75mm² white
 - white

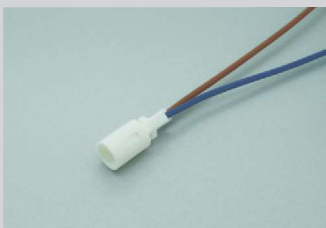

250FV

- Supply Lead**
- mini female socket
 - 2.5A/250V AC
 - terminal ends
 - H03VVH2-F 2x0.75mm² white
 - white



Euro-M+F

- Supply Lead**
- euro plug + euro socket
 - 2.5A/250V AC
 - H03VVH2-F 2x0.75mm² white
 - white



250YD2

- Y-Distributor**
- 2.5A/250V AC
 - 1mini plug + 2mini sockets
 - white



250YD2

- Y-Distributor**
- 2.5A/250V AC
 - 1mini plug + 2mini sockets(red hole=switch)
 - white

Mini HVL 760

250V 2.5A - MiniHVL760 connector system

7.6mm Diameter

PHOTO

Art No.

Description



250FM

- Direct connector
- 2.5A/250V AC
 - mini plug + mini socket
 - white



250MR

- PCB Mounted Plug
- 2.5A/250V AC
 - mini plug 90°
 - white



250FR

- PCB Mounted Socket
- 2.5A/250V AC
 - mini socket 90°
 - white



760BI

- Build-in Mounted Socket
- white



Example

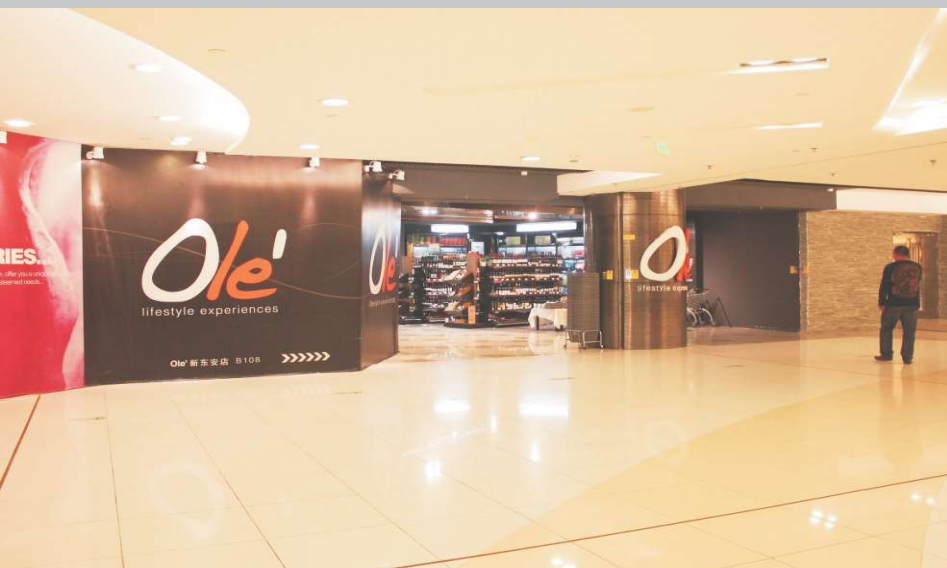

Shopping Center



Store



Display Cabinet



brown=plus" + "

blue=minus" - "

Mini HVL 760

7.6mm Mini HVL760 Connector System

7.6mm Mini HVL760 Steck System

50V/10A 2pole low voltage connector system for luminaires

- The 7.6mm MiniHVL760 connector system is designed according the IEC60320 standard for lighting industry applications. Applicable in power connection and coupling between lamps such as lighting wiring in offices, kitchen, bathroom, shop and household furniture, display cabinets and mountable lighting.
- 7.6mm outer diameter of mini plug to fit into 8mm furniture holes
- Connection: max.10A ,50V
- Cable: VDE H03VVH2-F 2×0.75mm²

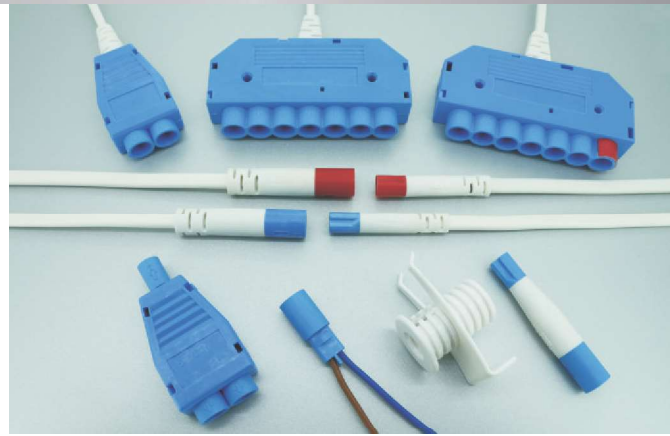

Mini HVL 760

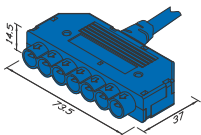
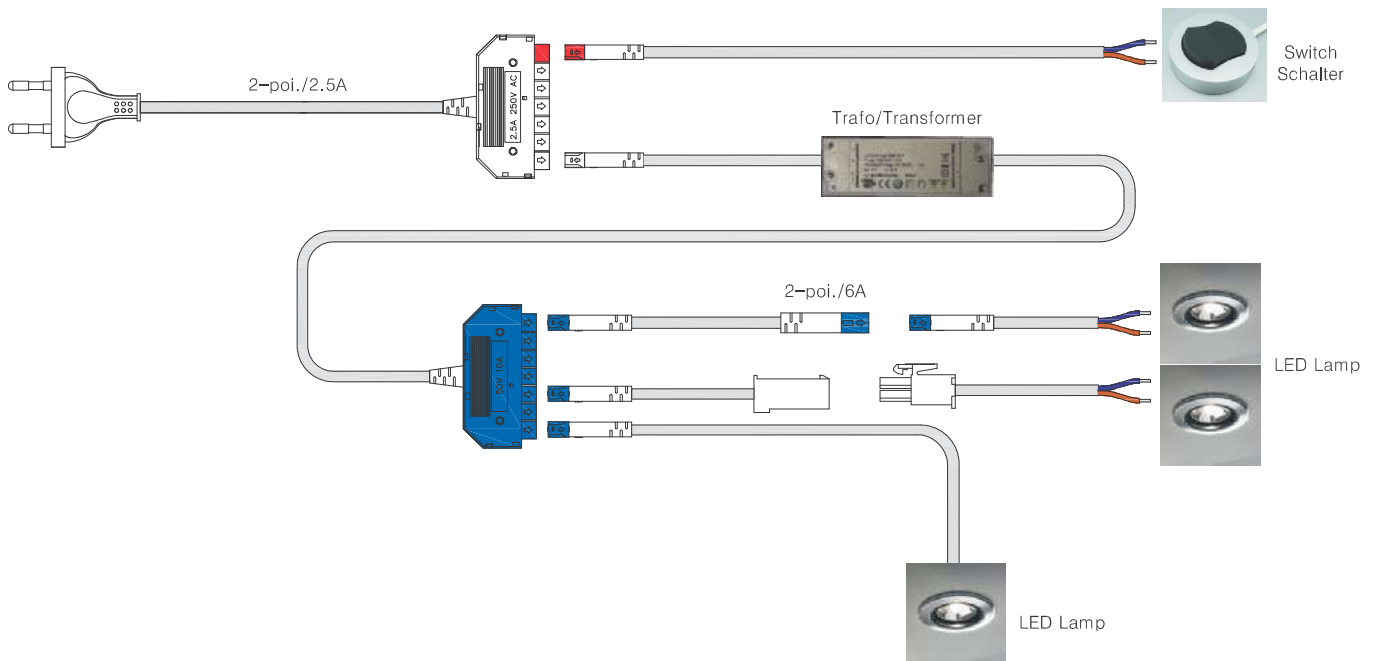

6-way distributor (1 way closed)
6-fach verteiler (1 fach geschlossen)
Art No:50D6

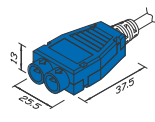

2-way distributor
2-fach verteiler
Art No:50D2

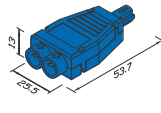

Y-distributor
Y-Verteiler
Art No:50YD2

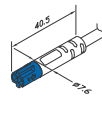

Mini male plug
M in stecker
Art No:50MP

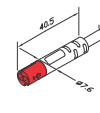

Red mini male plug
Rot m in stecker
Art No:250SMP

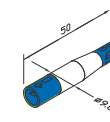

Direct connector
Direktverbinder
Art No:50FM

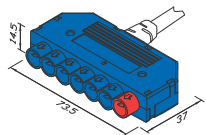

6-way distributor+switch
6-fach verteiler+schalter
Art No:50D7

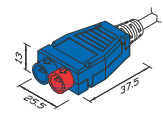

distributor+switch
1-fach verteiler+schalter
Art No:50D2

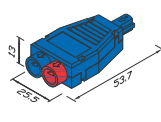

Y-distributor
Y-Verteiler
Art No:50YD2

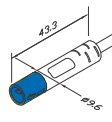

Mini female socket
M in buchse
Art No:50FS

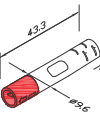



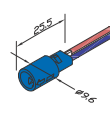



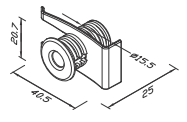

Red mini female socket
Rot m in buchse
Art No:250SFS



Mini female socket
M in buchse
Art No:50FV



Build-in socket
Einbau-buchse
Art No:760BI

PHOTO	Art No.	Description
	50MP	<p>Supply Lead</p> <ul style="list-style-type: none"> ■ mini male plug ■ 50V/6A ■ end tin ■ H03VVH2-F 2x0.75mm² white ■ blue
	50FS	<p>Supply Lead</p> <ul style="list-style-type: none"> ■ mini female socket ■ 50V/6A ■ terminal ends ■ H03VVH2-F 2x0.75mm² white ■ blue
	50FME	<p>Extension Lead</p> <ul style="list-style-type: none"> ■ mini male plug ■ mini female socket ■ 50V/6A ■ H03VVH2-F 2x0.75mm² white ■ blue
	250SMP	<p>Coded Supply Lead</p> <ul style="list-style-type: none"> ■ mini male plug for connecting switch ■ 50V/6A ■ end tin ■ H03VVH2-F 2x0.75mm² white ■ red
	250SFS	<p>Coded Supply Lead</p> <ul style="list-style-type: none"> ■ mini female socket for connecting switch ■ terminal ends ■ 50V/6A ■ H03VVH2-F 2x0.75mm² white ■ red
	250SMP + 250SFS	<p>Coded Extension Lead</p> <ul style="list-style-type: none"> ■ mini male plug for connecting switch ■ mini female socket ■ 50V/6A ■ H03VVH2-F 2x0.75mm² white ■ red
	50D7	<p>Supply Lead/6-way distributor+switch</p> <ul style="list-style-type: none"> ■ 6-way distributor+switch(red hole=switch) ■ terminal ends ■ 50V/10A ■ H03VVH2-F 2x0.75mm² white ■ blue
	50D6	<p>Supply Lead/6-way distributor</p> <ul style="list-style-type: none"> ■ 6-way distributor(1way closed) ■ Terminal ends ■ 50V/10A ■ H03VVH2-F 2x0.75mm² white ■ blue

Mini HVL 760

50V 10A - MiniHVL760 connector system

7.6mm Diameter

PHOTO

Art No.

Description



50D2

Supply Lead/2-way distributor

- 2-way distributor
- terminal ends
- 50V/10A
- H03VVH2-F 2x0.75mm² white
- blue



50FV

Supply Lead

- mini female socket
- 50V/6A
- terminal ends
- 0.75mm² blue and brown
- blue



50YD2

Y-Distributor

- 50V/10A
- 1mini plug + 2mini sockets
- blue



50YD2

Y-Distributor

- 50V/10A
- 1mini plug + 2mini sockets (red hole=switch)
- blue



50FM

Direct connector

- 50V/6A
- mini plug + mini socket
- blue



760BI

Build-in Mounted Socket

- white



◀ Example



brown=plus" + "
blue=minus" - "

Mini HVL 760

7.6mm Mini HVL760 Connector System

7.6mm Mini HVL760 Steck System

24V/10A 2pole low voltage connectorsystem for luminaires

- The 7.6mm MiniHVL760 connector system is designed according the IEC60320 standard for lighting industry applications. Applicable in power connection and coupling between lamps such as lighting wiring in offices, kitchen, bathroom, shop and household furniture, display cabinets and mountable lighting.
- 7.6mm outer diameter of mini plug to fit into 8mm furniture holes
- Connection: max.10A ,24V
- Cable: VDE H03VVH2-F 2x0.75mm²

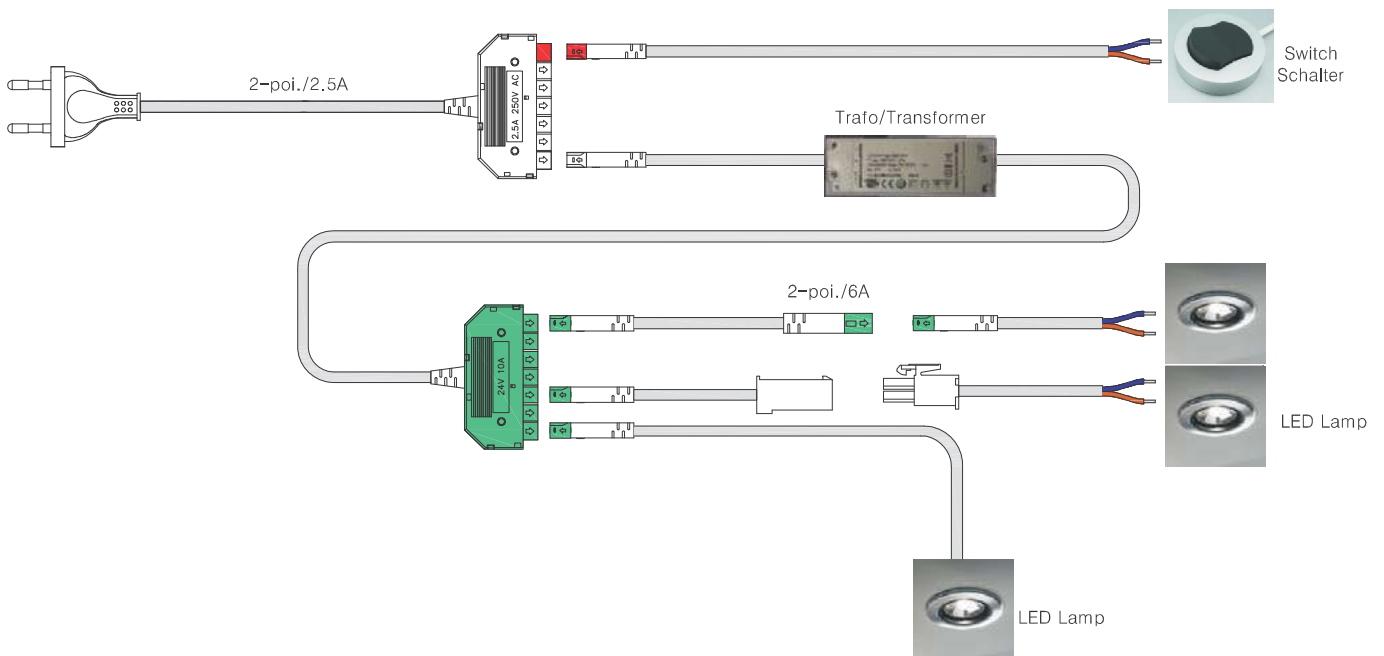
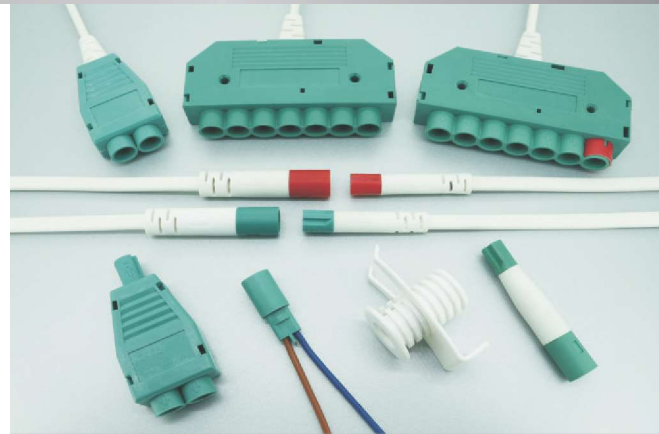

Mini HVL 760

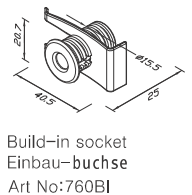
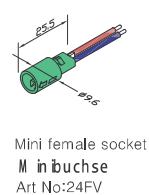
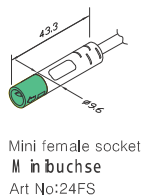
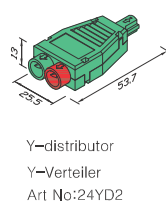
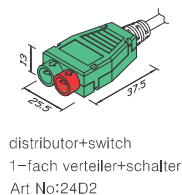
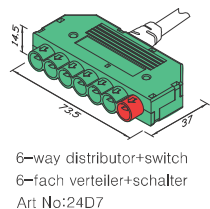
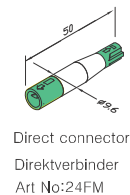
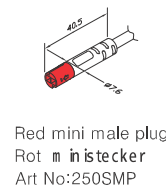
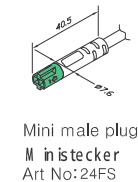
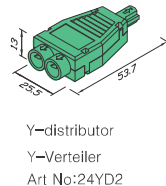
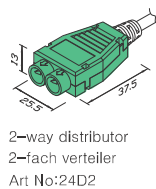
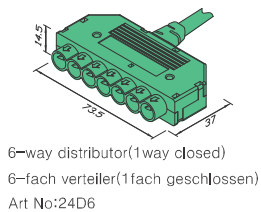

24V 10A - MiniHVL760 connector system

7.6mm Diameter

PHOTO

Art No.

Description



24MP

Supply Lead

- mini male plug
- 24V/6A
- end tin
- H03VVH2-F 2x0.75mm² white
- green



24FS

Supply Lead

- mini female socket
- 24V/6A
- terminal ends
- H03VVH2-F 2x0.75mm² white
- green



24FME

Extension Lead

- mini male plug
- mini female socket
- 24V/6A
- H03VVH2-F 2x0.75mm² white
- green



250SMP

Coded Supply Lead

- mini male plug for connecting switch
- 24V/6A
- end tin
- H03VVH2-F 2x0.75mm² white
- red

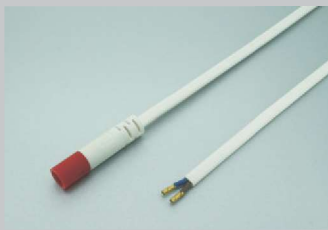

250SFS

Coded Supply Lead

- mini female socket for connecting switch
- terminal ends
- 24V/6A
- H03VVH2-F 2x0.75mm² white
- red



250SMP + 250SFS

Coded Extension Lead

- mini male plug for connecting switch
- mini female socket
- 24V/6A
- H03VVH2-F 2x0.75mm² white
- red

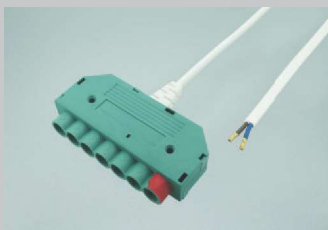

24D7

Supply Lead/6-way distributor+switch

- 6-way distributor+switch(red hole=switch)
- terminal ends
- 24V/10A
- H03VVH2-F 2x0.75mm² white
- green



24D6

Supply Lead/6-way distributor

- 6-way distributor(1way closed)
- terminal ends
- 24V/10A
- H03VVH2-F 2x0.75mm² white
- green

Mini HVL 760

24V 10A - MiniHVL760 connector system

7.6mm Diameter

PHOTO

Art No.

Description



24D2

Supply Lead/2-way distributor

- 2-way distributor
- terminal ends
- 24V/10A
- H03VVH2-F 2x0.75mm² white
- green

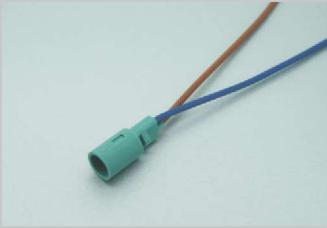

24FV

Supply Lead

- mini female socket
- 24V/6A
- terminal ends
- 0.75mm² blue and brown
- green



24YD2

Y-Distributor

- 24V/10A
- 1mini plug + 2mini sockets
- green



24YD2

Y-Distributor

- 24V/10A
- 1mini plug + 2mini sockets (red hole=switch)
- green



24FM

Direct connector

- 24V/6A
- mini plug + mini socket
- green



760BI

Build-in Mounted Socket

- white



◀ Example



brown=plus" + "
blue=minus" - "

Mini HVL 760

Switch System/Schalersysteme

- Installation: For surface and recess mounted with screw fixing
- 65 mm outer diameter
- Connection: max. 2.5A, 250V AC
- Cable: VDE H03VVH2-F 2x0.75mm²

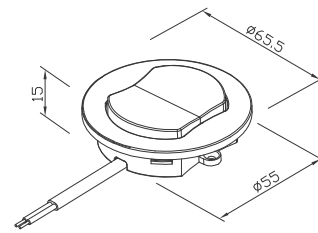
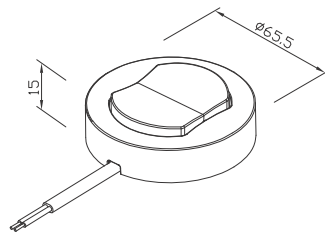
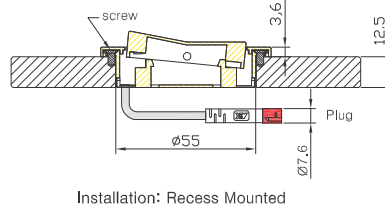
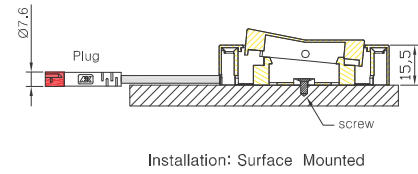
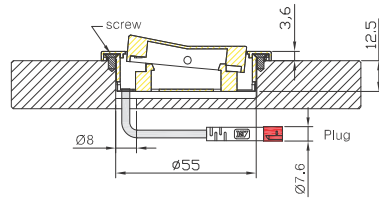
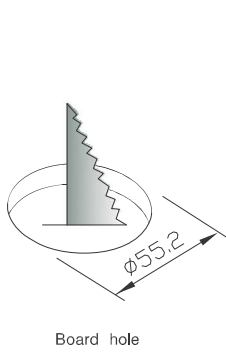
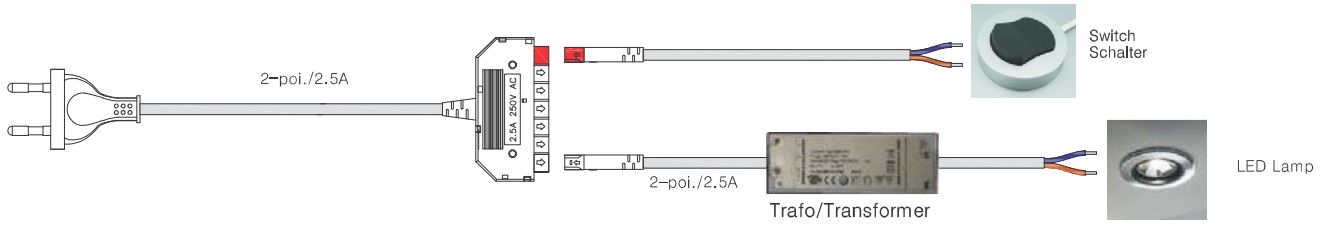



PHOTO	Art No.	Description
	308	Surface Mounted Switch Ø 65 ■ end minihvl 760 red plug ■ 2.5A/250V AC ■ H03VVH2-F 2x0.75mm ² white ■ silver colour
	309	Recess Mounted Switch Ø 65 ■ end minihvl 760 red plug ■ 2.5A/250V AC ■ H03VVH2-F 2x0.75mm ² white ■ silver colour

7.5mm Mini HVL Connector System

7.5mm Mini HVL Steck System

250V/2.5A 2pole high voltage connector system for luminaires

- The 7.5mm MiniHVL connector system is designed according the IEC60320 standard for lighting industry applications. Applicable in power connection and coupling between lamps such as lighting wiring in offices, kitchen, bathroom, shop and household furniture, display cabinets and mountable lighting.
- 7.5mm outer diameter of mini plug to fit into 8mm furniture holes
- Connection: max. 2.5A, 250V AC
- Cable: VDE H03VVH2-F 2x0.75mm²



250V

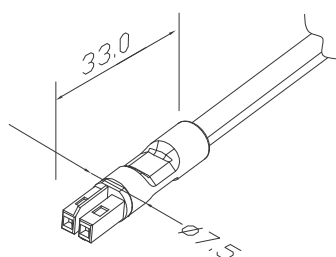
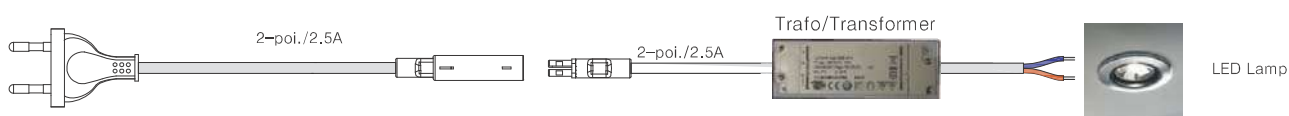

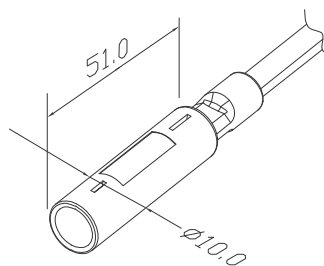

Description: mini male plug
Art No: 1740259-1



Description: mini female socket
Art No: 1740262-1

TYCO 7.5mm Mini HVL

PHOTO	Art No.	Description
	1740259-1	Supply Lead <ul style="list-style-type: none"> ■ TYCO mini male plug ■ 2.5A/250V AC ■ end tin ■ H03VVH2-F 2x0.75mm² white ■ white
	1740262-1	Supply Lead <ul style="list-style-type: none"> ■ TYCO mini female socket ■ 2.5A/250V AC ■ terminal ends ■ H03VVH2-F 2x0.75mm² white ■ white
		Extension Lead <ul style="list-style-type: none"> ■ TYCO mini male plug ■ mini female socket ■ 2.5A/250V AC ■ H03VVH2-F 2x0.75mm² white ■ white

7.6mm Mini RGB760 Connector System

- ## 7.6mm Mini RGB760 Steck System
- 3-Pole or 4-Pole Plug-in System for 12~24V LED RGB Strips
 - The connector system is a 3-pole or 4-pole appliance system, suitable for the RGB LED Strips, 5050SMD led strip and RGB lights.
 - Plug only 7.6mm outer diameter (fits through 8mm cavity)
 - Connection: max 6A, 24V
 - Cable: 20~24AWG 3C/4C

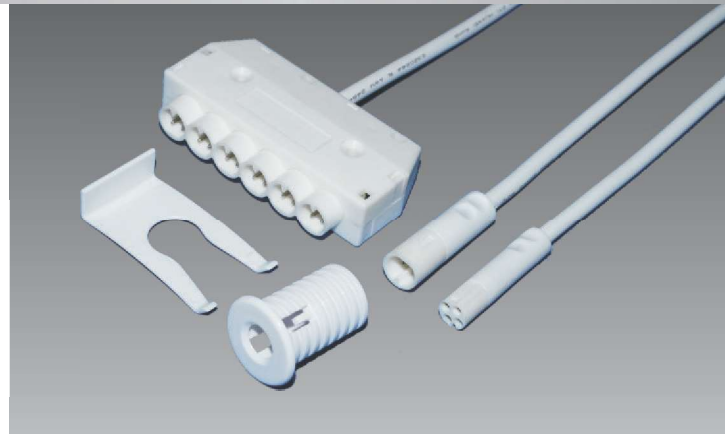

Mini RGB 760

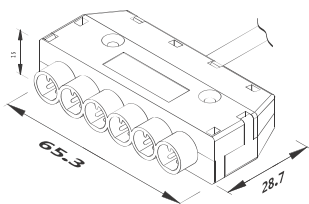
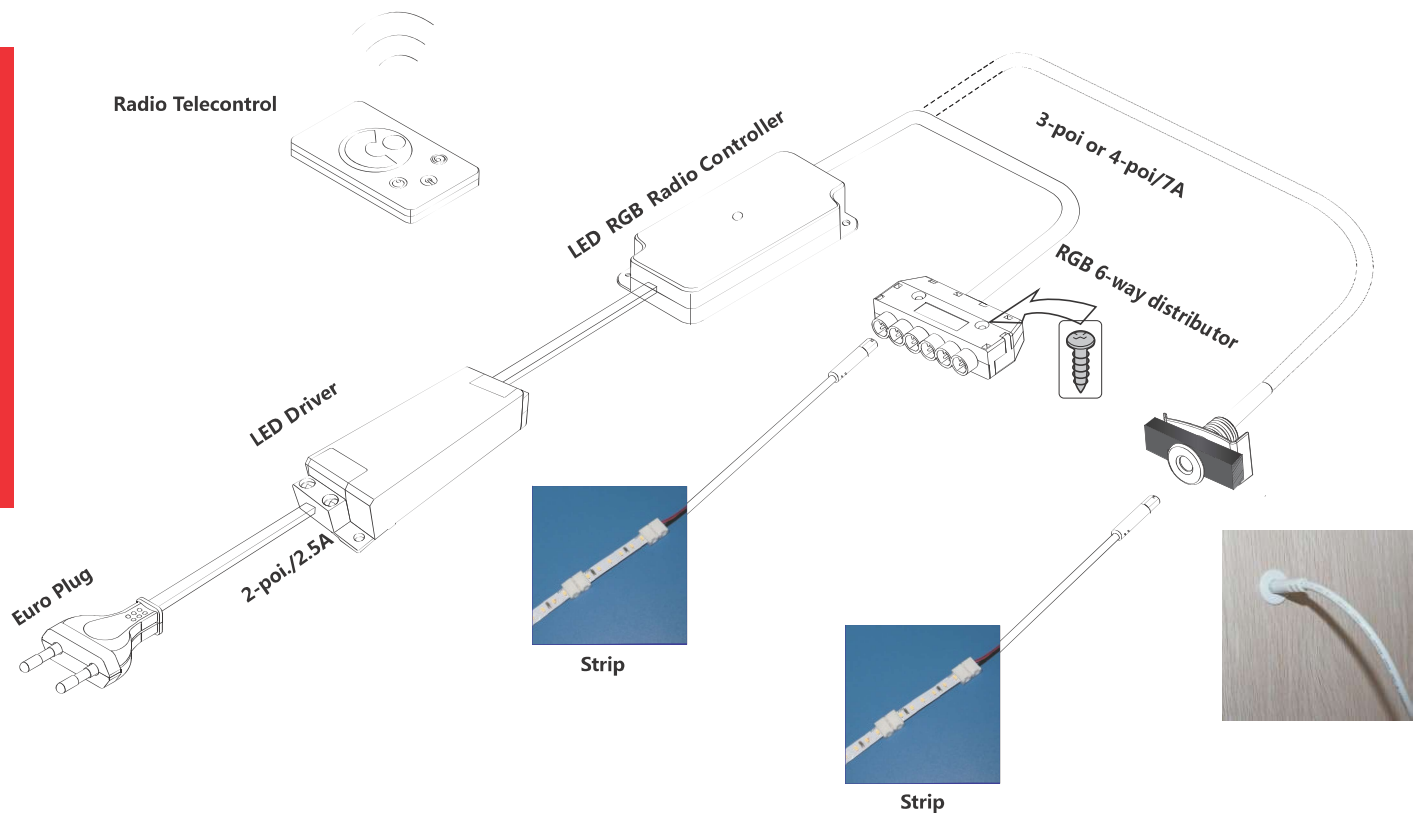

Description: 6-way distributor
Art No.: 3D6

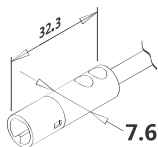

Description: Female Socket 3pin
Art No.: FS3

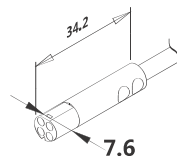

Description: male plug 3pin
Art No.: MP3

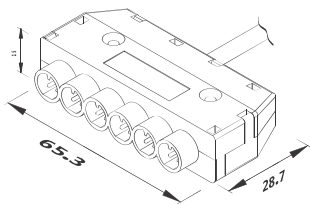

Description: 6-way distributor
Art No.: 4D6

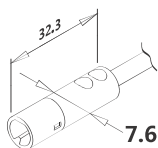



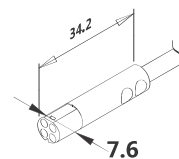

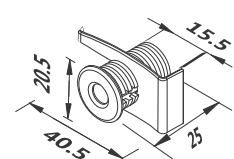

Description: Female Socket 4pin
Art No.: FS4



Description: male plug 4pin
Art No.: MP4

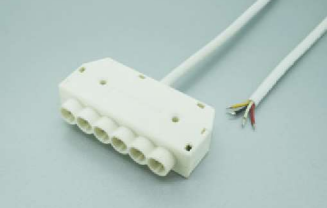

Build-in socket
Einbau-buchse
Art NO.: 760BI

PHOTO	Art No.	Description
	MP4	Supply Lead <ul style="list-style-type: none"> ■ mini male plug 4pin ■ max6A,24V ■ end tin ■ 20AWG cable white 4C ■ white
	MP3	Supply Lead <ul style="list-style-type: none"> ■ mini male plug 3pin ■ max6A,24V ■ end tin ■ 20AWG cable white 3C ■ white
	FS4	Supply Lead <ul style="list-style-type: none"> ■ mini female socket 4pin ■ max6A,24V ■ end tin ■ 20AWG cable white 4C ■ white
	FS3	Supply Lead <ul style="list-style-type: none"> ■ mini female socket 3pin ■ max6A,24V ■ end tin ■ 20AWG cable white 3C ■ white
	FME3 FME4	Extension Lead <ul style="list-style-type: none"> ■ mini male plug 4pin or 3pin ■ max6A,24V ■ mini female socket 4pin or 3pin ■ 20AWG cable white 3C or 4C ■ white
	MP3	Supply Lead <ul style="list-style-type: none"> ■ mini male plug 3pin ■ max3.5A,24V ■ end tin ■ 22AWG cable white 3C ■ white
	FS3	Supply Lead <ul style="list-style-type: none"> ■ mini female socket 3pin ■ max3.5A,24V ■ end tin ■ 22AWG cable white 3C ■ white
	4D6	Supply Lead/6-way distributor <ul style="list-style-type: none"> ■ 6-way distributor ■ end tin ■ max6A,24V ■ 20AWG cable white 4C ■ white

Mini RGB 760

24V 6A - Mini RGB760 connector system

7.6mm Diameter

PHOTO

Art No.

Description

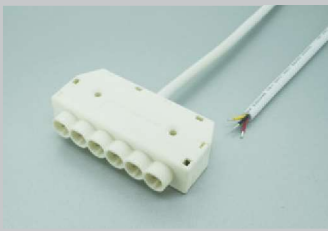

3D6

Supply Lead/6-way distributor

- 6-way distributor
- end tin
- 24V/6A
- 20AWG cable white 3C
- white



760BI

Build-in Mounted Socket

- white



Mini RGB 760

Example



Bar



Display Kitchen

Mini AMP Connector System Mini AMP Steck Systeme

2Pole 250V 7A High Voltage Connector System

- The connector system is a 2 pole appliance wiring system, suitable for using in ceiling lightings and floor lamps.
- Connection: max, 7A, 250V AC
- Cable: VDE H03VVH2-F2x0.75mm²

Test standards EN 60320-1:2001 ; EN60320-2-2 : 1998



250V

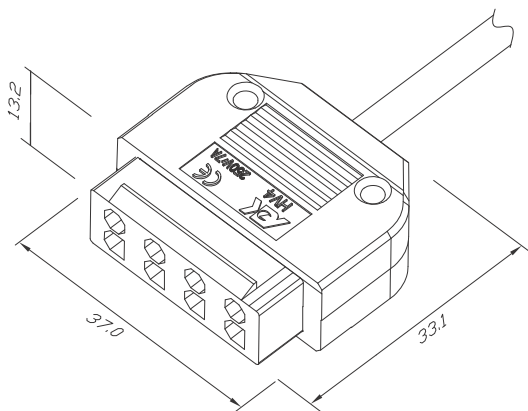
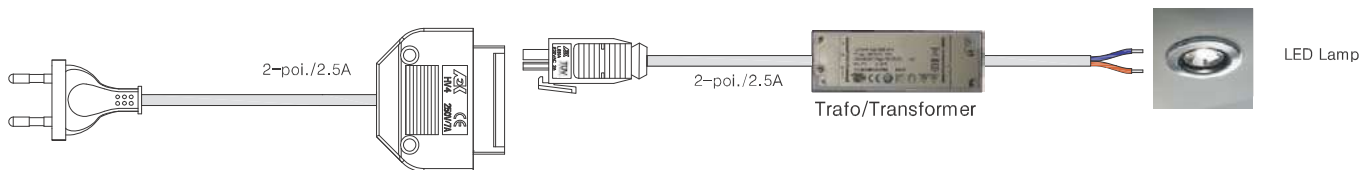
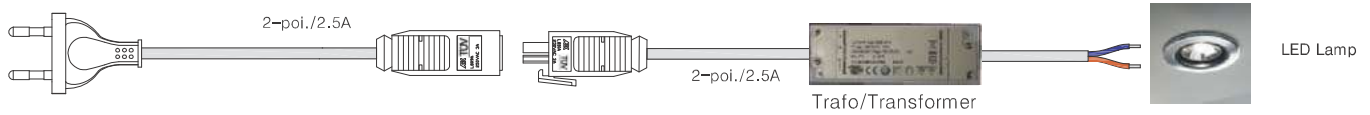

Description: 4way distributor
Art No: HV4

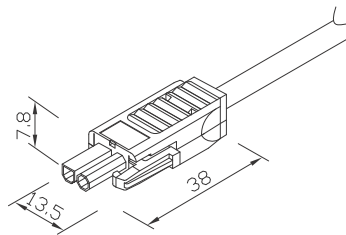

Description: Male Plug
Art No: L810A

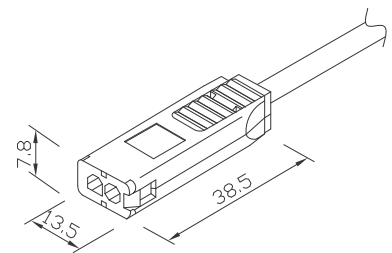

Description: female socket
Art No: L809A

Mini AMP

250V 7A Mini AMP connector system

PHOTO

Art No.

Description



HV4

Supply Lead/4-way distributor

- 4-way distributor
- terminal ends
- 7A/250V AC
- H03VVH2-F 2x0.75mm² white
- white



L810A

Supply Lead

- male plug
- 250V/7A AC
- end tin
- H03VVH2-F 2x0.75mm² white
- white



L809A

Supply Lead

- female socket
- 250V/7A AC
- end tin
- H03VVH2-F 2x0.75mm² white
- white



L811A

Extension Lead

- male plug
- female socket
- 250V/7A AC
- H03VVH2-F 2x0.75mm² white
- white



L810A

Supply Lead

- male plug
- 250V/7A AC
- end tin
- H03VVH2-F 2x0.75mm² white
- black



L809A

Supply Lead

- female socket
- 250V/7A AC
- end tin
- H03VVH2-F 2x0.75mm² white
- black



L811A

Extension Lead

- male plug
- female socket
- 250V/7A AC
- H03VVH2-F 2x0.75mm² white
- black



Euro-M+ L809A

Supply Lead

- mini AMP socket
- euro plug
- 7A/250V AC
- H03VVH2-F 2x0.75mm² white
- white

Mini AMP

12~30V Mini AMP Connector System for Halogen lights

- The mini AMP connector system is a 2 pole appliance wiring system, mini developed for the halogen lighting, also for cabinet LED lighting, furniture LED lighting, LED strips. It includes the coupling (plug & socket), 3-way distributor, 6-way distributor, 10-way distributors, which have parallel and series circuits.
- Connection: max. 10A, 12-30V
- Cable: VDE H03VVH2-F 2x0.75mm²

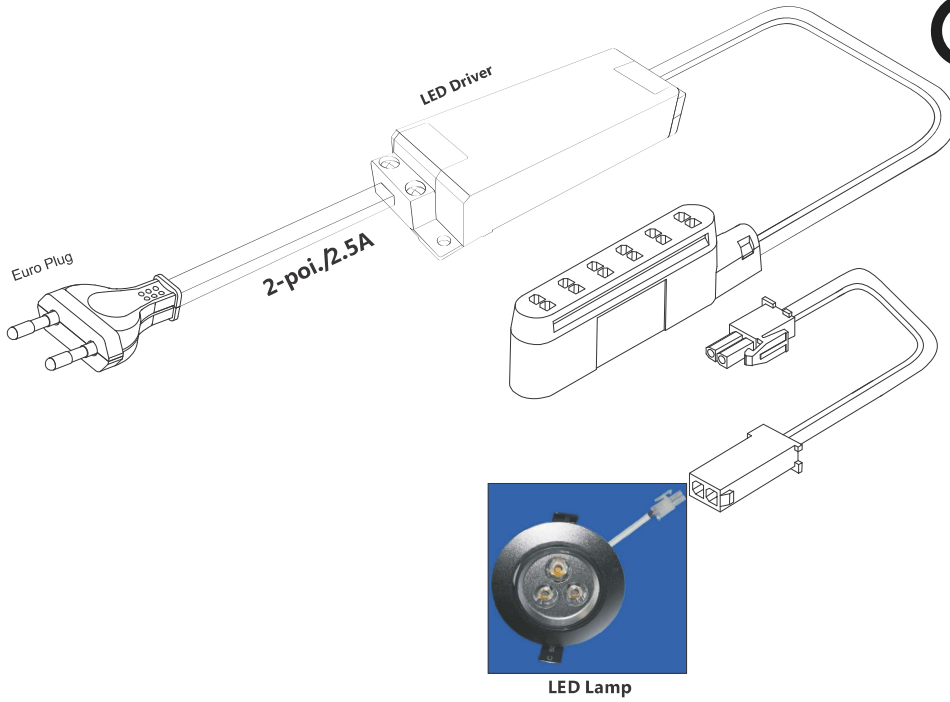
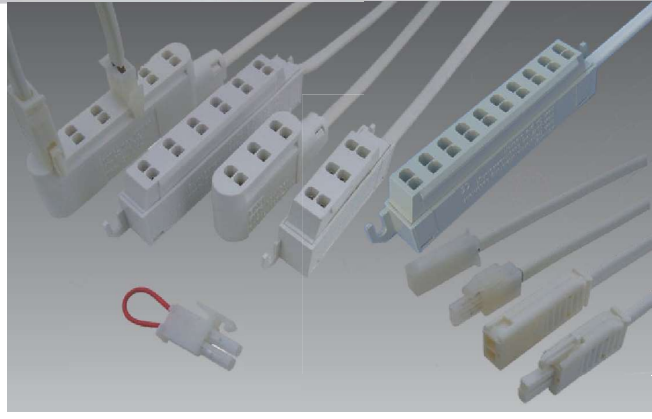

Mini AMP

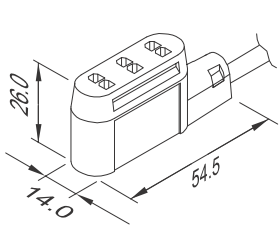

Description: 3-way distributor
Art No: L802A

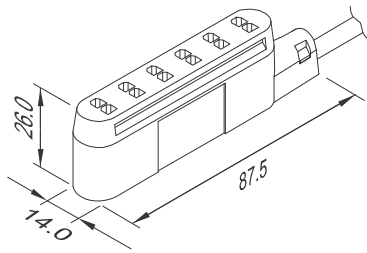

Description: 6-way distributor
Art No: L801A

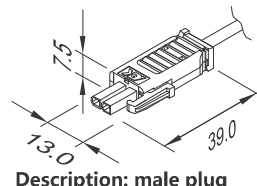

Description: male plug
Art No: L809

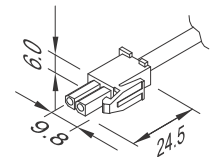

Description: male plug
Art No: L807

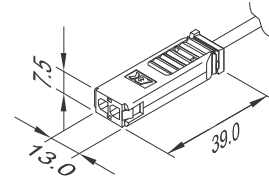

Description: female socket
Art No: L810

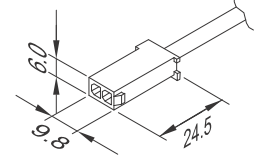

Description: female socket
Art No: L808

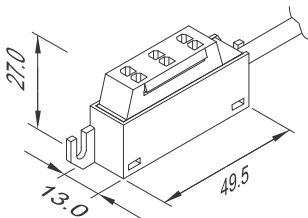

Description: 3-way distributor
Art No: L802B

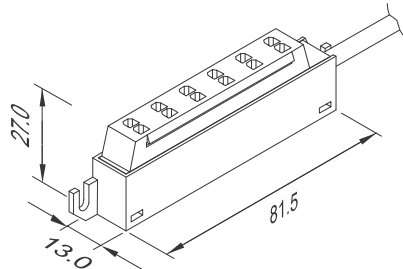

Description: 6-way distributor
Art No: L801B

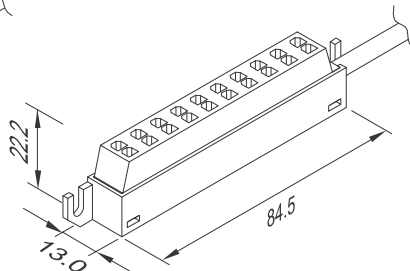



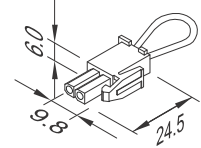



Description: 10-way distributor
Art No: L801C

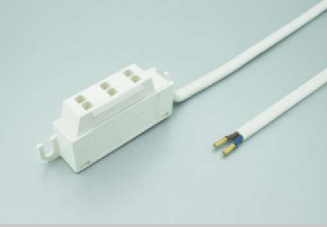

Description: male plug
Art No: L807S

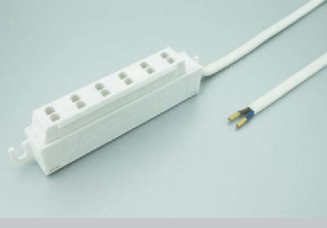
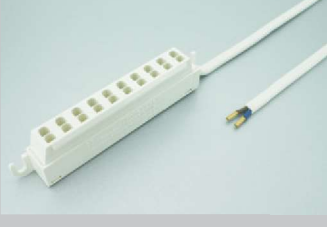
12~30V 10A - Mini AMP connector system

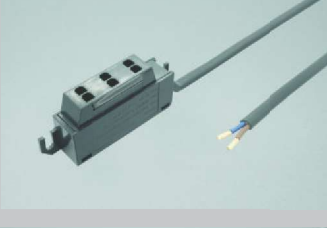
Mini AMP

PHOTO	Art No.	Description
	L802A	<p>3-way distributor</p> <ul style="list-style-type: none"> 3-way distributor terminal ends 12~30V/10A H03VVH2-F 2x0.75mm² white parallel or serial white
	L802B	<p>3-way distributor</p> <ul style="list-style-type: none"> 3-way distributor terminal ends 12~30V/10A H03VVH2-F 2x0.75mm² white parallel or serial white
	L801A	<p>6-way distributor</p> <ul style="list-style-type: none"> 6-way distributor terminal ends 12~30V/10A H03VVH2-F 2x0.75mm² white parallel or serial white
	L801B	<p>6-way distributor</p> <ul style="list-style-type: none"> 6-way distributor terminal ends 12~30V/10A H03VVH2-F 2x0.75mm² white parallel or serial white
	L801C	<p>10-way distributor</p> <ul style="list-style-type: none"> 10-way distributor terminal ends 12~30V/10A H03VVH2-F 2x0.75mm² white parallel white
	L802A	<p>3-way distributor</p> <ul style="list-style-type: none"> 3-way distributor terminal ends 12~30V/10A H03VVH2-F 2x0.75mm² black parallel or serial black
	L802B	<p>3-way distributor</p> <ul style="list-style-type: none"> 3-way distributor terminal ends 12~30V/10A H03VVH2-F 2x0.75mm² parallel or serial black
	L801A	<p>6-way distributor</p> <ul style="list-style-type: none"> 6-way distributor terminal ends 12~30V/10A H03VVH2-F 2x0.75mm² black parallel or serial black

12~30V 10A - Mini AMP connector system

PHOTO	Art No.	Description
	L801B	<p>6-way distributor</p> <ul style="list-style-type: none"> 6-way distributor terminal ends 12~30V/10A H03VVH2-F 2x0.75mm² black parallel or serial black
	L801C	<p>10-way distributor</p> <ul style="list-style-type: none"> 10-way distributor terminal ends 12~30V/10A H03VVH2-F 2x0.75mm² black parallel black
	L809	<p>Supply Lead</p> <ul style="list-style-type: none"> 12~30V/6A mini plug end tin H03VVH2-F 2x0.75mm² white white
	L810	<p>Supply Lead</p> <ul style="list-style-type: none"> 12~30V/6A mini socket terminal ends H03VVH2-F2x0.75mm² white white
	L810P	<p>Extension Lead</p> <ul style="list-style-type: none"> 12~30V/6A mini plug + mini socket H03VVH2-F 2x0.75mm² white white
	L809	<p>Supply Lead</p> <ul style="list-style-type: none"> 12~30V/6A mini plug end tin H03VVH2-F 2x0.75mm² black black
	L810	<p>Supply Lead</p> <ul style="list-style-type: none"> 12~30V/6A mini socket terminal ends H03VVH2-F2x0.75mm² black black
	L810P	<p>Extension Lead</p> <ul style="list-style-type: none"> 12~30V/6A mini plug + mini socket H03VVH2-F 2x0.75mm² black black

Mini AMP

12~30V 10A - Mini AMP connector system

PHOTO

Art No.

Description



L807

Supply Lead

- 12~30V/6A
- mini plug
- end tin
- H03VVH2-F 2x0.75mm² white
- white



L808

Supply Lead

- 12~30V/6A
- mini socket
- terminal ends
- H03VVH2-F 2x0.75mm² white
- white



L808P

Extension Lead

- 12~30V/6A
- mini plug + mini socket
- H03VVH2-F 2x0.75mm² white
- white



L809S

Serial Connection

- 12~30V/6A
- mini plug
- 22AWG red
- white



L807S

Serial Connection

- 12~30V/6A
- mini plug
- 22AWG red
- white

Mini AMP

Example



12V LED Mini Connector System for LED lights

- The mini connector system is a 2 pole appliance wiring system, developed for the cabinet LED lighting, furniture LED lighting, LED strips. It includes the coupling (plug & socket), 3-way distributor, 4-way distributor, 6-way distributor, 10 way distributor as well as two PCB sockets. All distributors which have parallel and series circuits.
- Plug only 5.0mm size (fits through 8mm furniture holes)
- Connection: 3A, 12V DC
- Cable: VDE H03VVH2-F 2x0.5mm² or LIYZ 2x0.34mm²

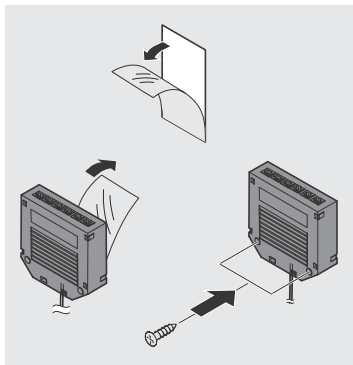
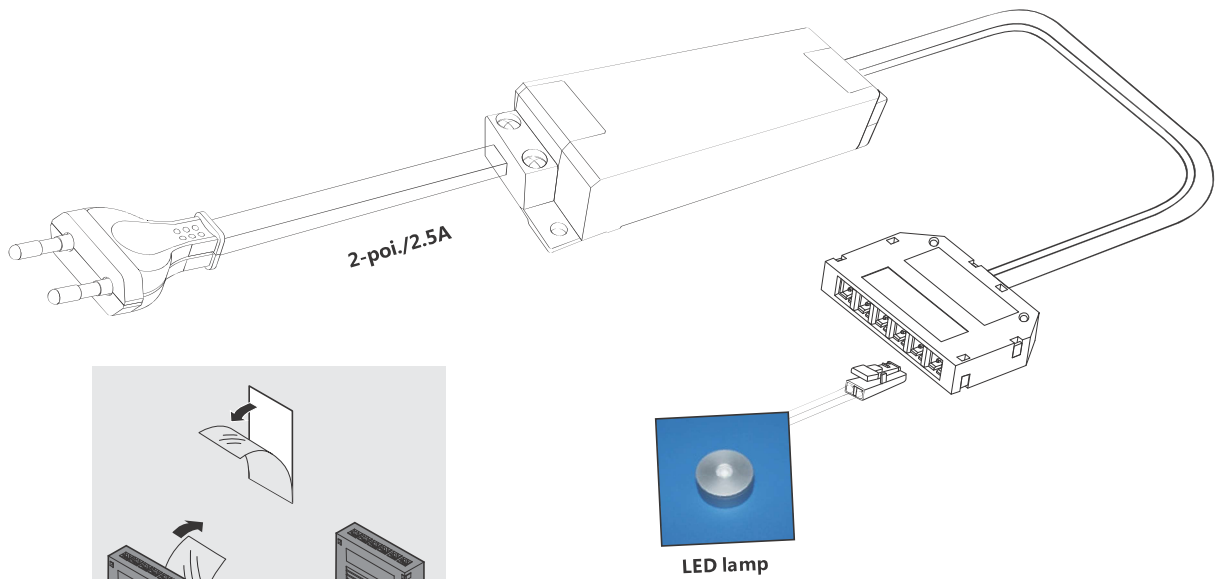

LV 806

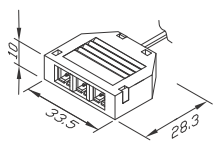

NEW
Description: 3-way distributor
Art No: L806-3

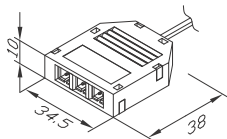

Description: 3-way distributor
Art No: L806-3

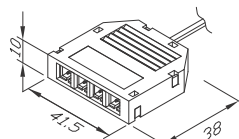

Description: 4-way distributor
Art No: L806-4

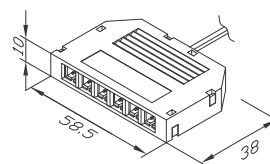

Description: 6-way distributor
Art No: L806-6

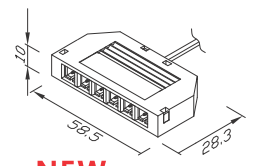

NEW
Description: 6-way distributor
Art No: L806-6

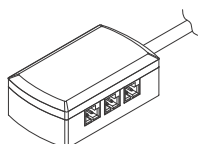

Description: 6-way distributor
Art No: L805-6

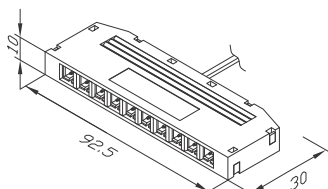

Description: 10-way distributor
Art No: L806-10

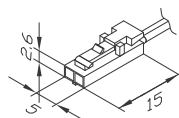

Description: male plug
Art No: L813

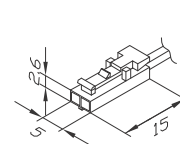

Description: male plug
Art No: L814

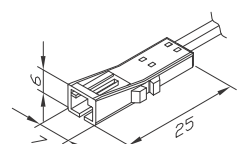

Description: female socket
Art No: L815

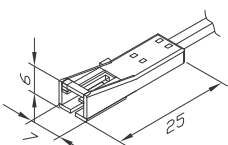

Description: female socket
Art No: L816

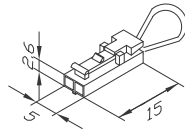

Description: male plug
Art No: L814S

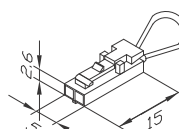

Description: male plug
Art No: L813S

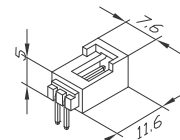



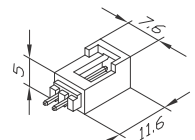

Description: PCB 90° socket
Art No: 2541WR











Description: PCB 180° socket
Art No: 2541WV

12V 7A/24V 3.5A - Mini LV806 connector system

LV 806

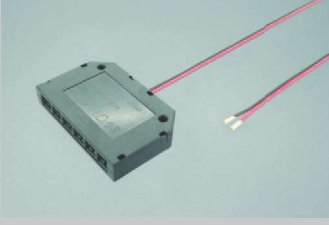
PHOTO	Art No.	Description
	L806-3W	<p>3-way distributor</p> <ul style="list-style-type: none"> 3-way distributor terminal ends 12V 7A/with cable 2*0.75mm² 24V 3.5A/with cable 2*0.75mm² parallel or serial white
	L806-4W	<p>4-way distributor</p> <ul style="list-style-type: none"> 4-way distributor terminal ends 12V 7A/with cable 2*0.75mm² 24V 3.5A/with cable 2*0.75mm² parallel or serial white
	L806-4SW	<p>4-way distributor</p> <ul style="list-style-type: none"> 4-way distributor with Screw holes terminal ends 12V 7A/with cable 2*0.75mm² 24V 3.5A/with cable 2*0.75mm² parallel or serial white
	L806-6W	<p>6-way distributor</p> <ul style="list-style-type: none"> 6-way distributor terminal ends 12V 7A/with cable 2*0.75mm² 24V 3.5A/with cable 2*0.75mm² parallel or serial white
	L806-6SW	<p>6-way distributor</p> <ul style="list-style-type: none"> 6-way distributor with Screw holes terminal ends 12V 7A/with cable 2*0.75mm² 24V 3.5A/with cable 2*0.75mm² parallel or serial white
 NEW	L806-6PW	<p>6-way distributor</p> <ul style="list-style-type: none"> 6-way distributor terminal ends 12V 7A/with cable 2*0.75mm² 24V 3.5A/with cable 2*0.75mm² parallel or serial white
	L806-10W	<p>10-way distributor</p> <ul style="list-style-type: none"> 10-way distributor terminal ends 12V 7A/with cable 2*0.75mm² 24V 3.5A/with cable 2*0.75mm² parallel or serial white
	L806-3B	<p>3-way distributor</p> <ul style="list-style-type: none"> 3-way distributor terminal ends 12V 7A/with cable 2*0.75mm² 24V 3.5A/with cable 2*0.75mm² parallel or serial black

12V 7A/24V 3.5A - Mini LV806 connector system

PHOTO	Art No.	Description
	L806-3PB	<p>3-way distributor</p> <ul style="list-style-type: none"> 3-way distributor terminal ends 12V 7A/with cable 2*0.75mm² 24V 3.5A/with cable 2*0.75mm² parallel or serial black
	L806-4B	<p>4-way distributor</p> <ul style="list-style-type: none"> 4-way distributor terminal ends 12V 7A/with cable 2*0.75mm² 24V 3.5A/with cable 2*0.75mm² parallel or serial black
	L806-4SB	<p>4-way distributor</p> <ul style="list-style-type: none"> 4-way distributor with Screw holes terminal ends 12V 7A/with cable 2*0.75mm² 24V 3.5A/with cable 2*0.75mm² parallel or serial black
	L806-6B	<p>6-way distributor</p> <ul style="list-style-type: none"> 6-way distributor terminal ends 12V 7A/with cable 2*0.75mm² 24V 3.5A/with cable 2*0.75mm² parallel or serial black
	L806-6SB	<p>6-way distributor</p> <ul style="list-style-type: none"> 6-way distributor with Screw holes terminal ends 12V 7A/with cable 2*0.75mm² 24V 3.5A/with cable 2*0.75mm² parallel or serial black
	L806-6PB	<p>6-way distributor</p> <ul style="list-style-type: none"> 6-way distributor terminal ends 12V 7A/with cable 2*0.75mm² 24V 3.5A/with cable 2*0.75mm² parallel or serial black
	L806-10B	<p>10-way distributor</p> <ul style="list-style-type: none"> 10-way distributor terminal ends 12V 7A/with cable 2*0.75mm² 24V 3.5A/with cable 2*0.75mm² parallel or serial black
	L814	<p>Supply Lead</p> <ul style="list-style-type: none"> 12~24V/3A mini plug end tin LIYZ 2x0.34mm² white/black white

12V 7A/24V 3.5A - Mini LV806 connector system

PHOTO

Art No.

Description



L816

Supply Lead

- 12~24V/3A
- mini socket
- end tin
- LIYZ 2x0.34mm² white/black
- white



L818

Extension Lead

- 12~24V/3A
- mini plug + mini socket
- LIYZ 2x0.34mm² white/black
- white



L814S

Serial Connection

- 12~24V/3A
- mini plug
- 22AWG red
- white

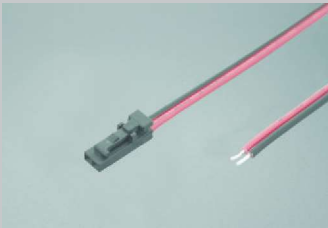

L813

Supply Lead

- 12~24V/3A
- mini plug
- end tin
- LIYZ 2x0.34mm² black/red
- black



L815

Supply Lead

- 12~24V/3A
- mini socket
- end tin
- LIYZ 2x0.34mm² black/red
- black

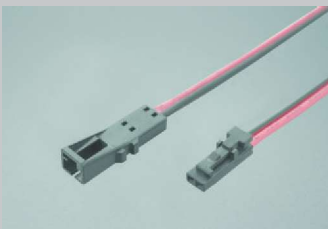

L817

Extension Lead

- 12~24V/3A
- mini plug + mini socket
- LIYZ 2x0.34mm² black/red
- black

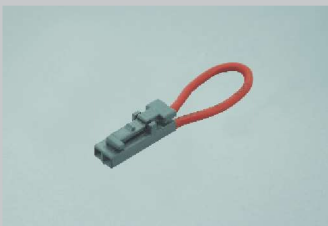

L813S

Serial Connection

- 12~24V/3A
- mini plug
- 22AWG red
- black

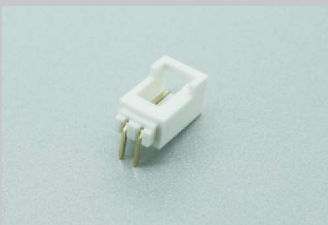



2541WRW

PCB Socket

- 12~24V/7A
- mini socket 90°
- white

LV 806 908 A7

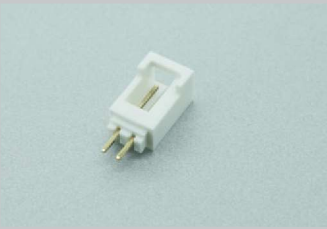
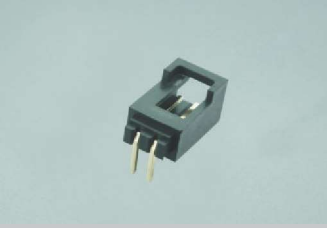
12V 7A/24V 3.5A - Mini LV806 connector system

PHOTO	Art No.	Description
	2541WVW	<p>PCB Socket</p> <ul style="list-style-type: none"> ■ 12~24V/7A ■ mini socket 180° ■ white
	2541WRB	<p>PCB Socket</p> <ul style="list-style-type: none"> ■ 12~24V/7A ■ mini socket 90° ■ black
	2541WVB	<p>PCB Socket</p> <ul style="list-style-type: none"> ■ 12~24V/7A ■ mini socket 180° ■ black

LV 806

Example



Display cabinet



Kitchen



Showcase

24V LV MX24 Connector System for LED lights

- The mini connector system is a 2 pole appliance wiring system, developed for the cabinet LED lighting, furniture LED lighting, LED strips. It includes the coupling (plug & socket), 2-way distributor (one side), 4-way distributor (one side) and 6-way distributor as well as two PCB sockets. All distributors have parallel and series circuits.
- Connection: max. 3A, 24V
- Cable: VDE H03VVH2-F 2x0.75mm² or LIYZ 2x0.34mm²

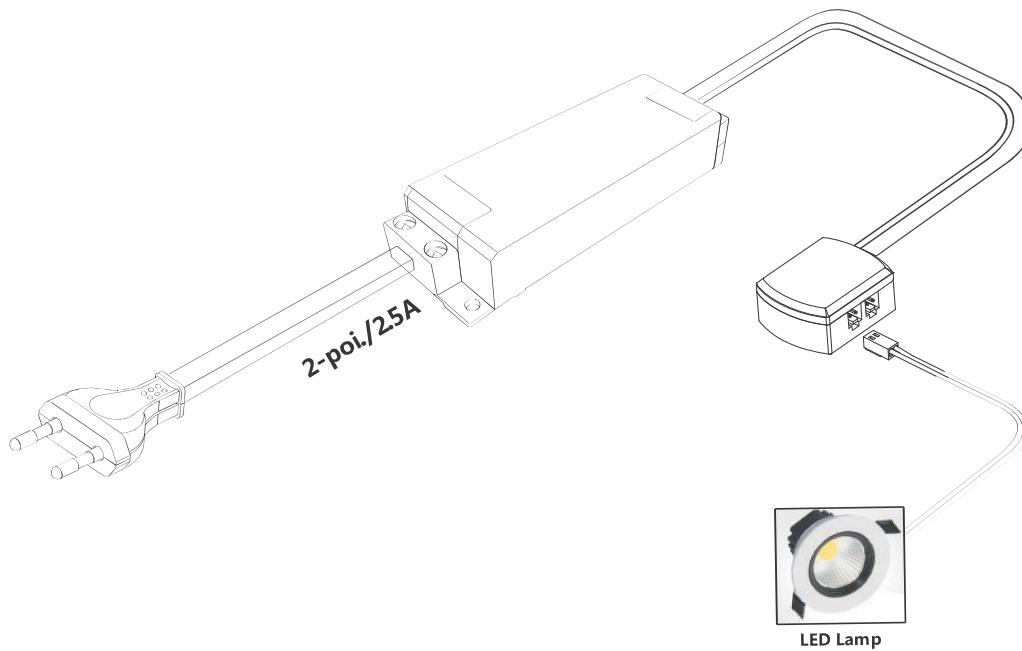
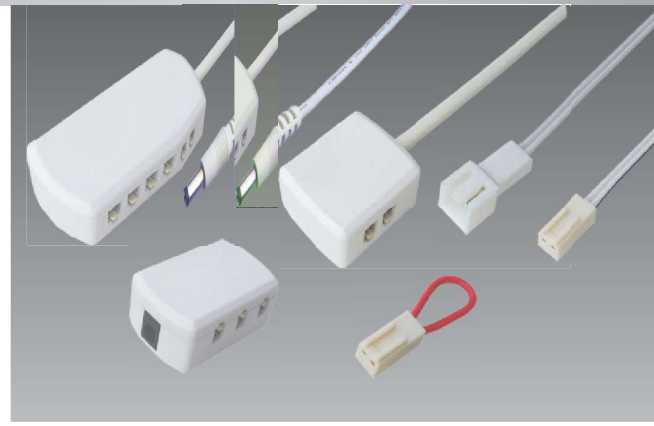

LV
MX24

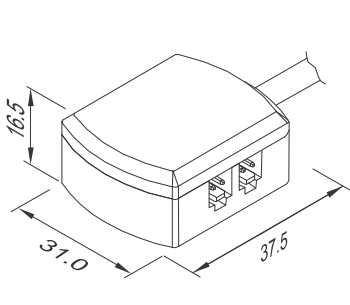

Description: 2-way and 4 way distributor
Art No: L803-2/L803-4

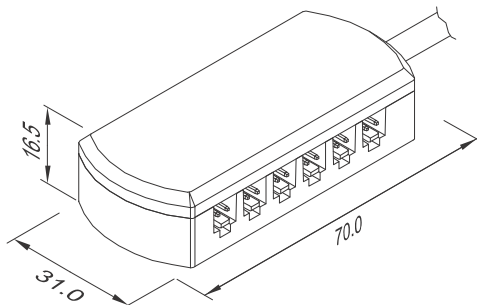

Description: 6-way and 12 way distributor
Art No: L803-6/L803-12

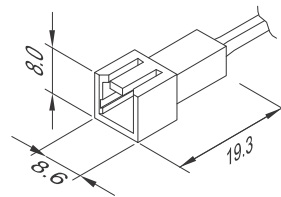

Description: female socket
Art No: L822P

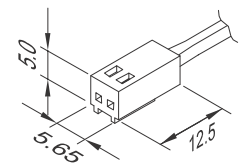

Description: male plug
Art No: L822

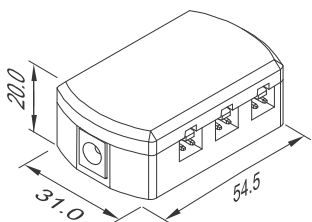

Description: 6-way distributor
Art No: L803C

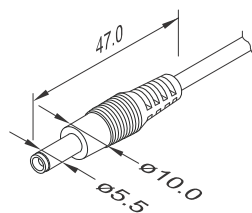

Description: DC male plug
Art No: L828

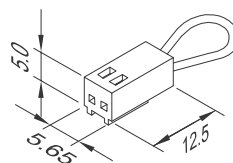

Description: male plug
Art No: L822S

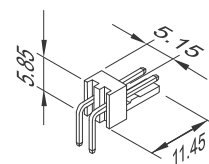



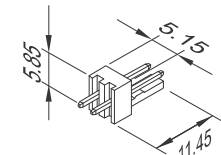



Description: PCB 90° socket
Art No: 2542WR



Description: PCB 180° socket
Art No: 2542WV

24V 3A - LV MX24 connector system

PHOTO	Art No.	Description
	L822	Supply Lead <ul style="list-style-type: none"> ■ male plug ■ 24V/3A ■ end tin ■ LIYZ 2x0.34mm² white ■ white
	L822P	Supply Lead <ul style="list-style-type: none"> ■ mini female socket ■ 24V/3A ■ end tin ■ LIYZ 2x0.34mm² white ■ white
	L812	Extension Lead <ul style="list-style-type: none"> ■ mini male plug ■ mini female socket ■ 24V/3A ■ LIYZ 2x0.34mm² white ■ white
	L822S	Serial Connection <ul style="list-style-type: none"> ■ mini male plug ■ 24V/3A ■ 22AWG red ■ white
	L803-2 L803-4	2-way/4-way distributor <ul style="list-style-type: none"> ■ 2-way/4-way distributor ■ terminal ends ■ 24V/3A ■ H03VVH2-F 2x0.75mm² white ■ parallel or serial ■ white
	L803-6 L803-12	6-way/12-way distributor <ul style="list-style-type: none"> ■ 6-way/12-way distributor ■ terminal ends ■ 24V/3A ■ H03VVH2-F 2x0.75mm² white ■ parallel or serial ■ white
	L803C	6-way distributor <ul style="list-style-type: none"> ■ 6-way distributor+DC5521 socket ■ 24V/3A ■ parallel or serial ■ white

24V LV JST24 Connector System for LED lights

- The mini connector system is a 2 pole appliance wiring system, developed for the cabinet LED lighting, furniture LED lighting, LED strips. It includes the coupling (plug & socket), 3-way distributor (one side), 6-way distributor and 10-way distributor as well as two PCB sockets. All distributors have parallel and series circuits.
- Connection: max. 5A, 24V
- Cable: VDE H03VVH2-F 2x0.75mm² or LIYZ 2x0.34mm²



LV JST24

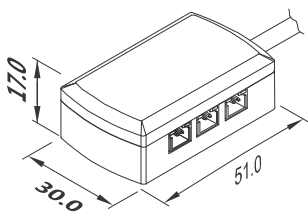
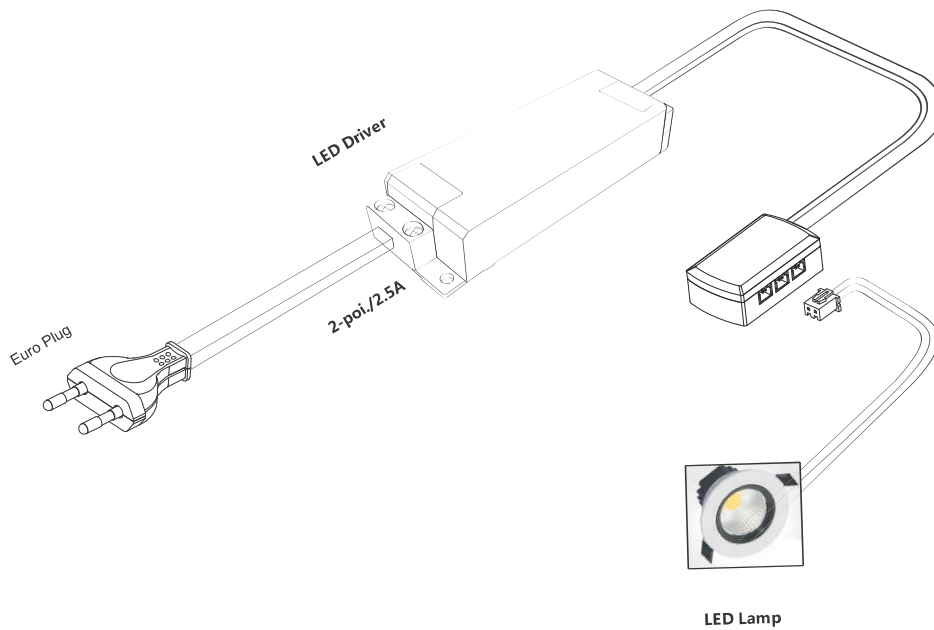

Description: 3-way and 6 way distributor
Art No: L804-3/L804-6

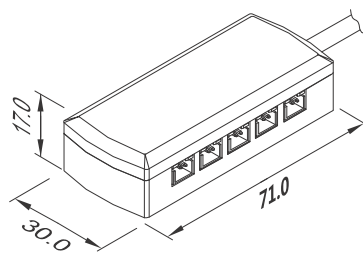

Description: 10-way distributor
Art No: L804-10/L804-5

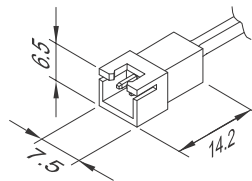

Description: female socket
Art No: L824

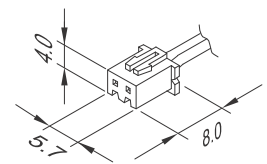

Description: male plug
Art No: L823

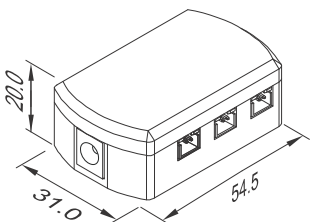

Description: 6-way distributor
Art No: L804C

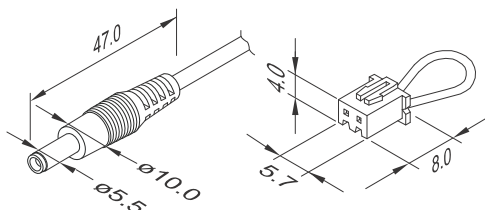

Description: DC male plug
Art No: L828

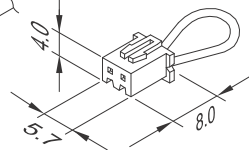

Description: male plug
Art No: L823S

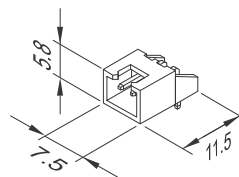

Description: PCB 90° socket
Art No: 2501PX-2P

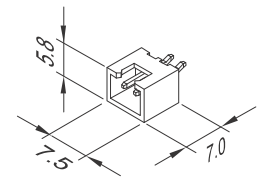

Description: PCB 180° socket
Art No: 2501PX-2P

12~24V 3A - LV JST24 connector system

PHOTO	Art No.	Description
	L823	Supply Lead <ul style="list-style-type: none"> male plug 12~24V/3A end tin LIYZ 2x0.34mm² white white
	L824	Supply Lead <ul style="list-style-type: none"> mini female socket 12~24V/3A end tin LIYZ 2x0.34mm² white white
	L823EL	Extension Lead <ul style="list-style-type: none"> mini male plug mini female socket 12~24V/3A LIYZ 2x0.34mm² white white
	L823S	Serial Connection <ul style="list-style-type: none"> mini male plug 12~24V/3A 22AWG red white
	L804-3 L804-6	3-way/6-way distributor <ul style="list-style-type: none"> 3-way/6-way distributor terminal ends 12~24V/5A parallel or serial H03VVH2-F 2x0.75mm² white white
	L804-5 L804-10	5-way/10-way distributor <ul style="list-style-type: none"> 5-way/10-way distributor terminal ends 12~24V/5A parallel or serial H03VVH2-F 2x0.75mm² white white
	L804C	6-way distributor <ul style="list-style-type: none"> 6-way distributor+DC5521 socket parallel or serial 12~24V/5A white

LV JST24

Mini RGB Connector System

- The connector system is a 4 pole appliance wiring system, developed for the flexible RGB LED strips 5050 SMD flexible LED strips and RGB Lights. the coupling (plug&socket), 4-way distributor, and 9-way distributor.
- Connection: 3A, 24V
- Cable: 22AWG/4C

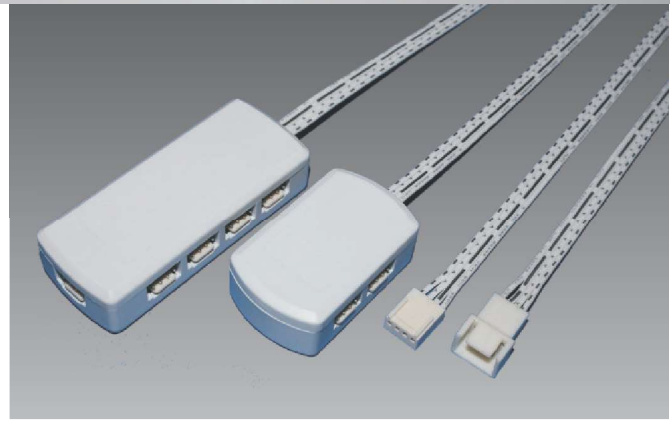

T06 A7

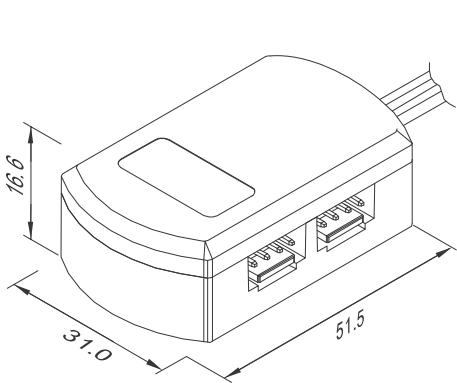
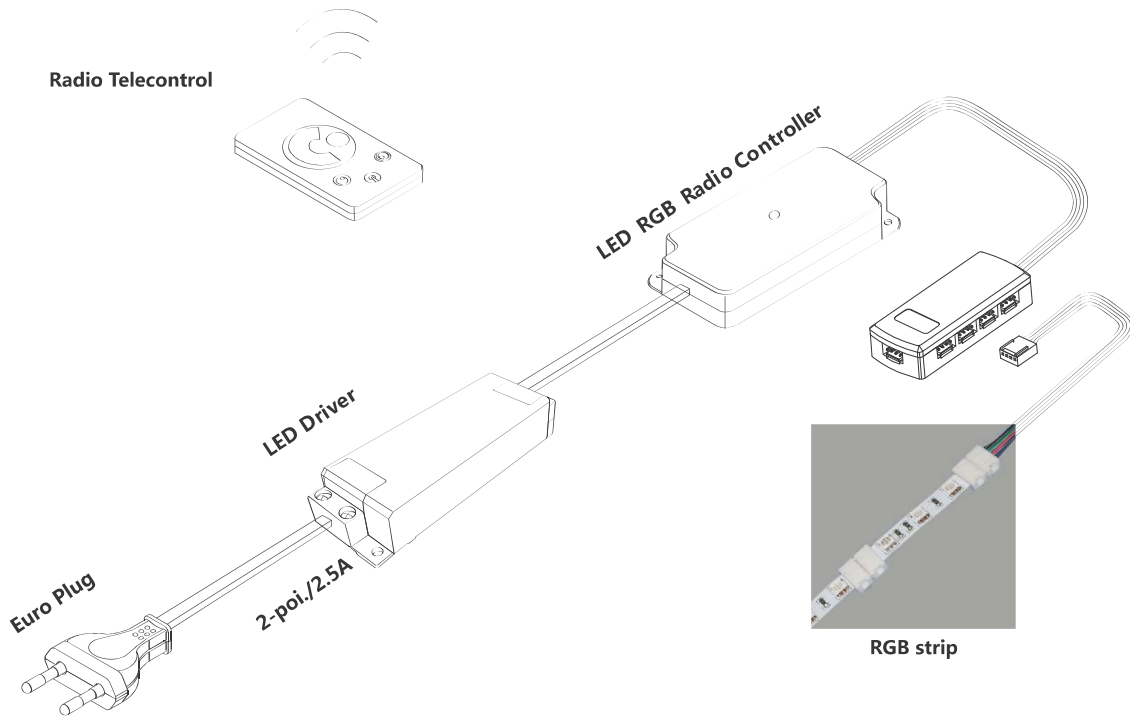

Description: 4-way distributor
Art No: L901A

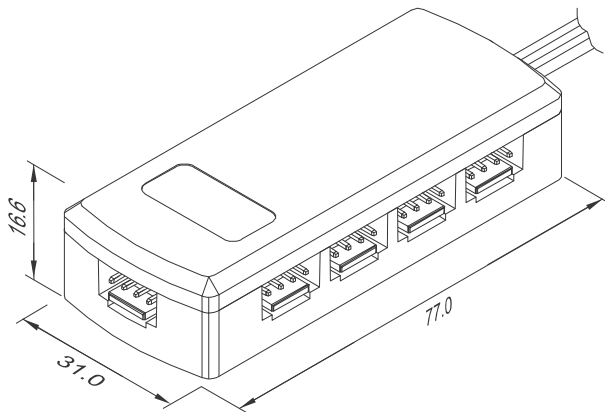

Description: 9-way distributor
Art No: L901B

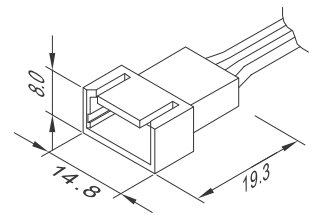

Description: female socket
Art No: L834

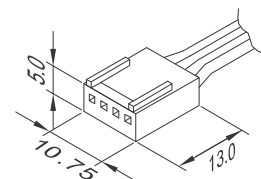

Description: male plug
Art No: L822-4

24V 3A - LV 901 connector system

PHOTO	Art No.	Description
	L822-4	Supply Lead <ul style="list-style-type: none"> ■ male plug ■ 24V/3A ■ end tin ■ 22AWG/4C white ■ white
	L834	Supply Lead <ul style="list-style-type: none"> ■ female socket ■ 24V/3A ■ end tin ■ 22AWG/4C white ■ white
	L834P	Extension Lead <ul style="list-style-type: none"> ■ male plug ■ female socket ■ 24V/3A ■ 22AWG/4C white ■ white
	L901A	4-way distributor <ul style="list-style-type: none"> ■ 4-way distributor ■ 24V/3A ■ end tin ■ 22AWG/4C white ■ white
	L901B	9-way distributor <ul style="list-style-type: none"> ■ 9-way distributor ■ 24V/3A ■ end tin ■ 22AWG/4C white ■ white

LV 901

Example



Restroom



Bar

Mini RGB Connector System

- The connector system is a 5 pole appliance wiring system, developed for the flexible RGB LED strips 5050 SMD flexible LED strips and RGB Lights. the coupling (plug&socket), 4-way distributor.
- Connection: 3A, 24V
- Cable: 22AWG/5C



LV 902

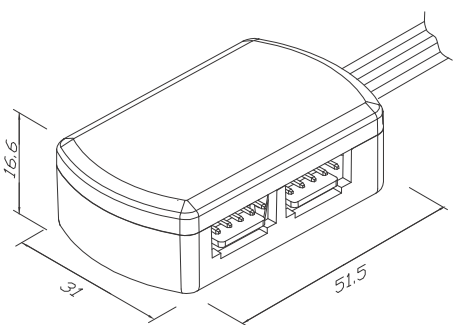
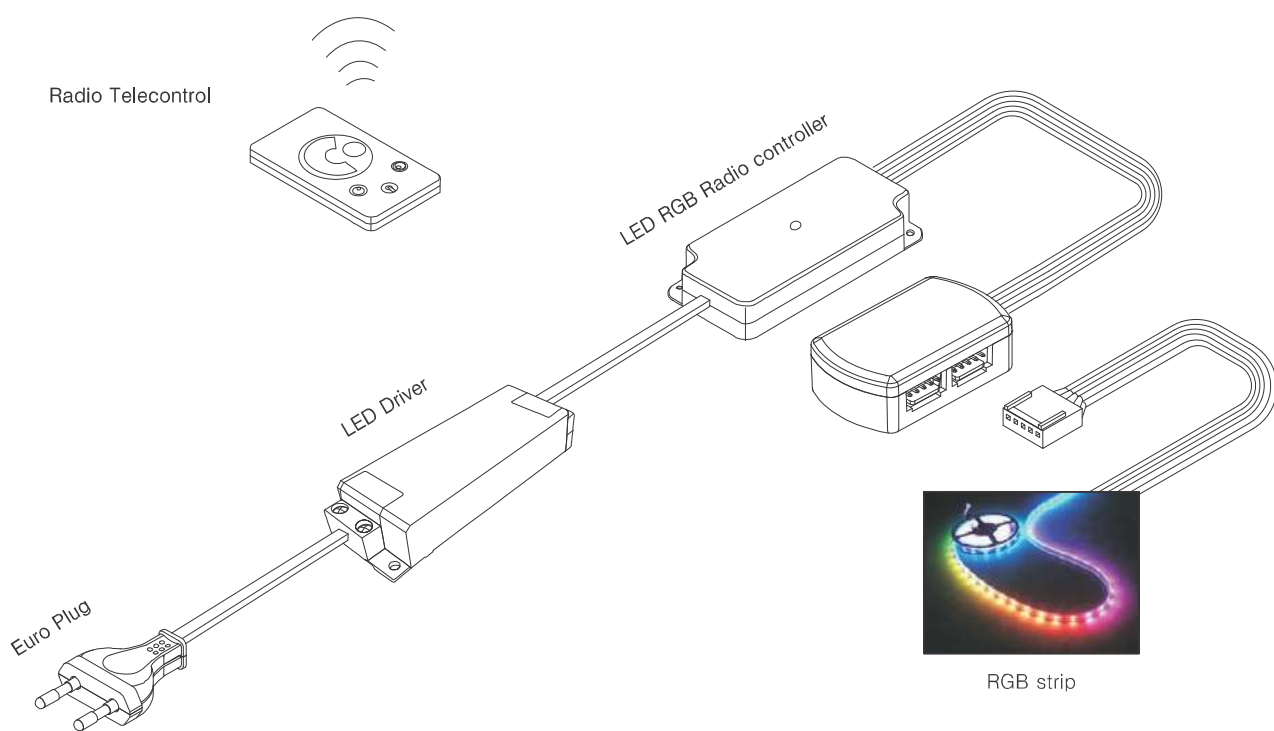

Description: 4-way distributor(5 Pin)
Art No: L902

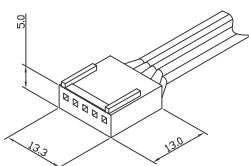



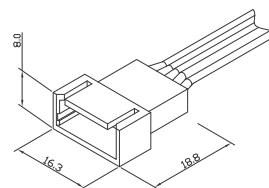

Description: male plug
Art No: L822-5

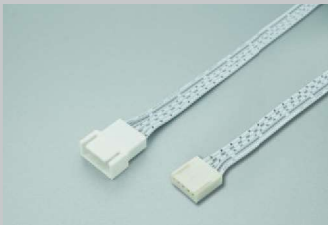

Description: female socket
Art No: L835

24V 3A - LV 902 RGB connector system

PHOTO	Art No.	Description
	L822-5	Supply Lead <ul style="list-style-type: none"> ■ male plug ■ 24V/3A ■ end tin ■ 22AWG/5C white ■ white
	L835	Supply Lead <ul style="list-style-type: none"> ■ female socket ■ 24V/3A ■ end tin ■ 22AWG/5C white ■ white
	L835P	Extension Lead <ul style="list-style-type: none"> ■ male plug ■ female socket ■ 24V/3A ■ 22AWG/5C white ■ white
	L902	4-way distributor <ul style="list-style-type: none"> ■ 4-way distributor ■ 24V/3A ■ end tin ■ 22AWG/5C white ■ white

LV 902

Example



Restroom



Bar

24V Mini Connector System for LED Strips

- The mini connector system is a 2 pole appliance wiring system, developed for the LED strip 3528 (Strip width: 8.0mm)
- Plug only 8.65mm width
- Connection: max. 3A, 24V
- Cable: UL 2468 22AWG 2pin
- Pitch: 2.54mm



LV SS24

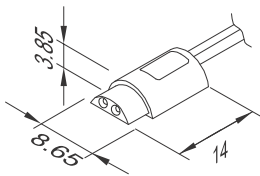
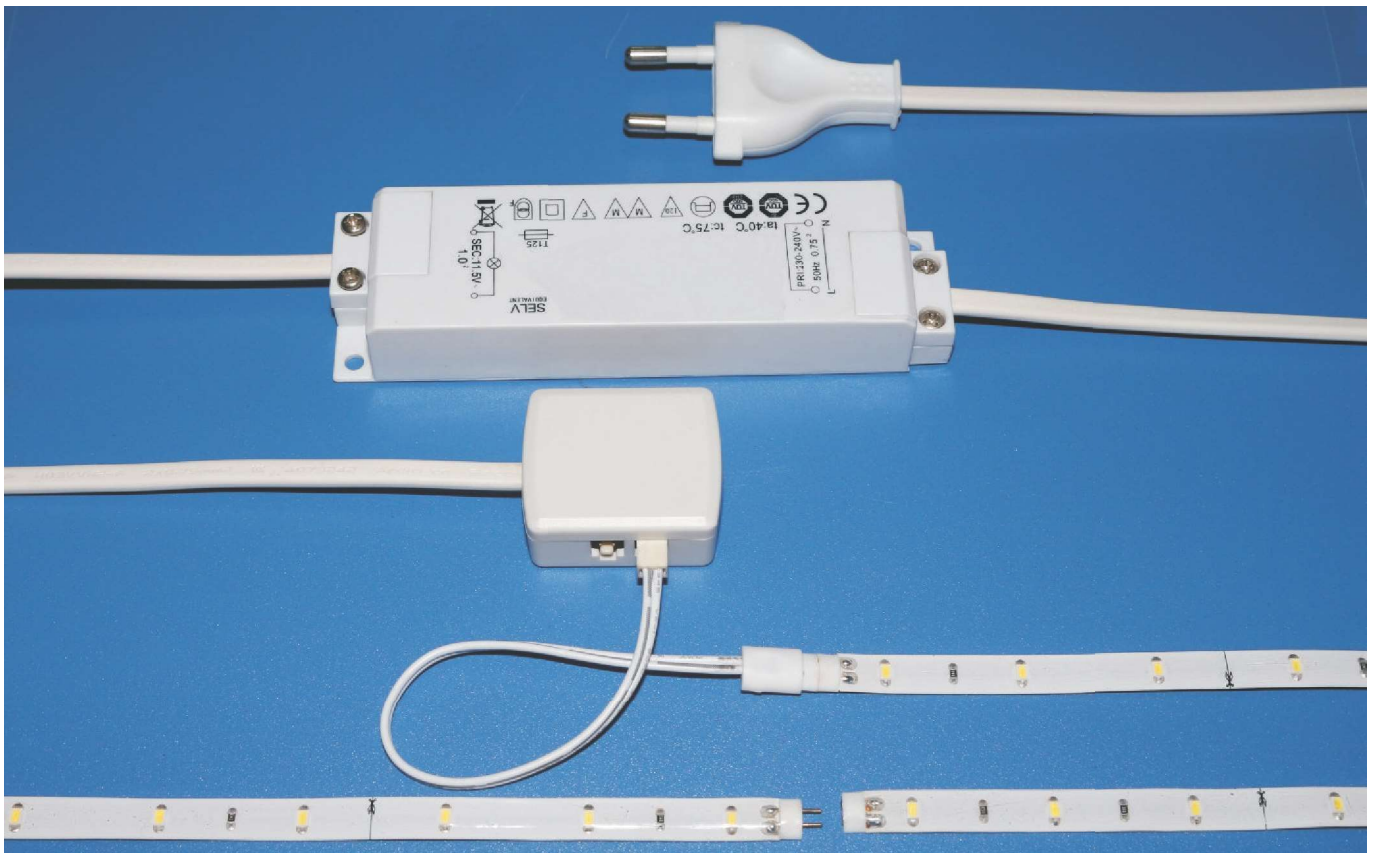

Description: female socket
Art No: L841

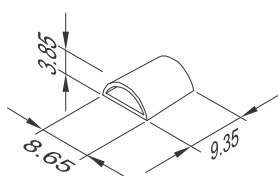

Description: soft sleeve
Art No: L842

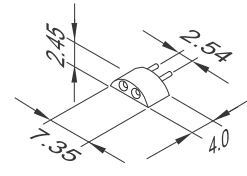

Description: female socket without cable
Art No: L841P

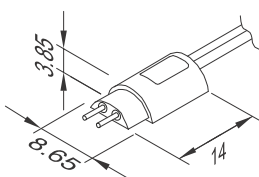



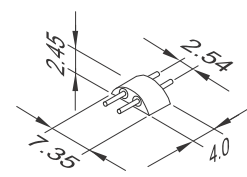
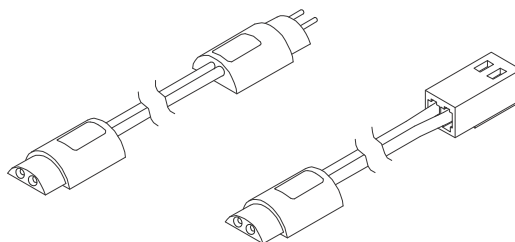

Description: male plug
Art No: L840

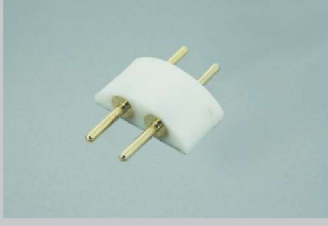

Description: male plug without cable
Art No: L840P

24V 3A - LV SS24 LED strips connector system

PHOTO	Art No.	Description
	L840	Supply Lead <ul style="list-style-type: none"> male plug 24V/3A end tin 22AWG/2C white white
	L841	Supply Lead <ul style="list-style-type: none"> female socket 24V/3A end tin 22AWG/2C white white
	L840E	Extension Lead <ul style="list-style-type: none"> male plug female socket 24V/3A 22AWG/2C white white
	L840P	Accessories <ul style="list-style-type: none"> PCB Male Header 24V/3A white
	L841P	Accessories <ul style="list-style-type: none"> PCB Female Header 24V/3A white
	L842	Accessories <ul style="list-style-type: none"> soft sleeve

LV SS24

Example



Bedroom



Stair



Display cabinet

24V Mini Connector System for LED RGB Strips

- The mini connector system is a 2 pole appliance wiring system, developed for the flexible RGB LED Strips, 5050 SMD Flexible led strip
- Plug only 11.5mm width
- Connection: max. 3A, 24V DC
- Cable: UL 2468 22AWG 4pin
- Pitch: 2.0mm

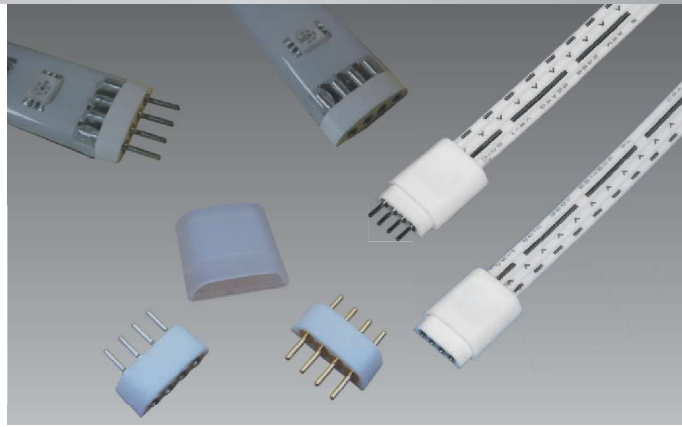

LV SR24

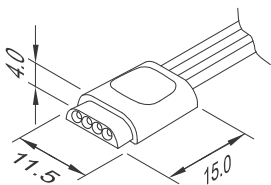
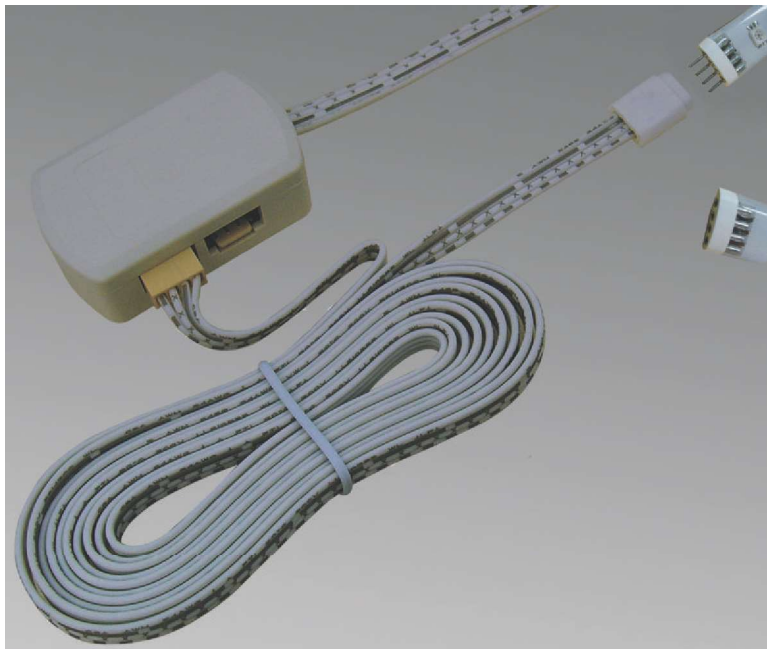

Description: female socket
Art No: L844

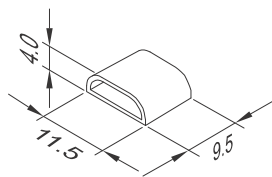

Description: soft sleeve
Art No: L845

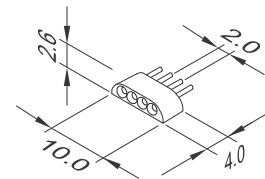

Description: female socket without cable
Art No: L844P

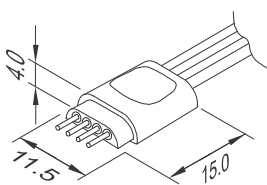



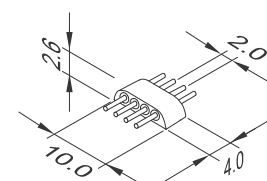
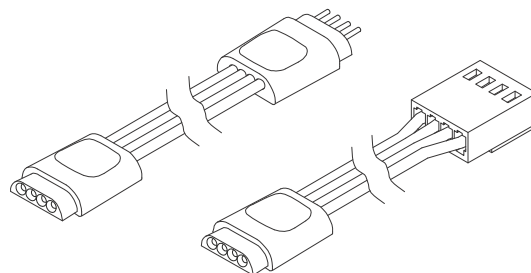

Description: male plug
Art No: L843

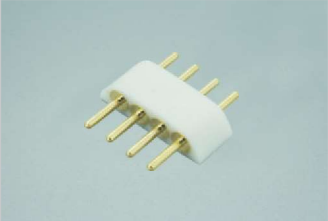

Description: male plug without cable
Art No: L843P

24V 3A - LV SR24 LED strips connector system

PHOTO	Art No.	Description
	L843	Supply Lead <ul style="list-style-type: none"> male plug 24V/3A end tin 22AWG/4C white white
	L844	Supply Lead <ul style="list-style-type: none"> female socket 24V/3A end tin 22AWG/4C white white
	L843E	Extension Lead <ul style="list-style-type: none"> male plug female socket 24V/3A 22AWG/4C white white
	L843P	Accessories <ul style="list-style-type: none"> PCB Male Header 24V/3A white
	L844P	Accessories <ul style="list-style-type: none"> PCB Female Header 24V/3A white
	L845	Accessories <ul style="list-style-type: none"> soft sleeve

LV SR24

Example



Hall

24V Mini Connector System for LED Strips

- The connector system is a 2 pole and 4 pole appliance wiring system, developed for the flexible RGB LED Strips, 5050 SMD Flexible led strips.
- Suitable flexible length: 8mm and 10mm
- Connection: max. 3A, 24V DC
- Cable: UL 2468 22AWG 2pin, 4pin

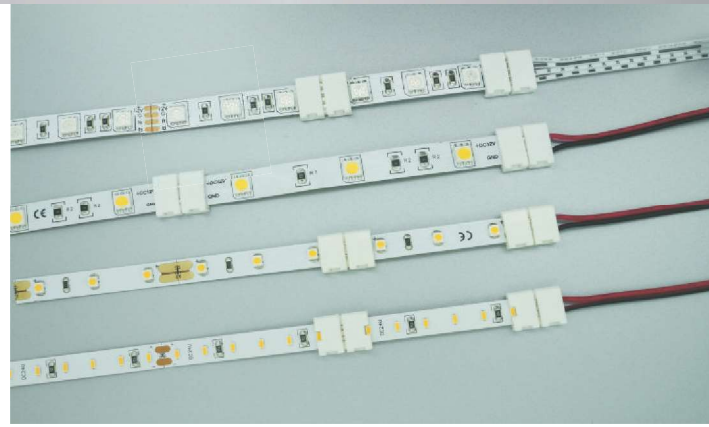

LV SSR24



24V 3A - LV SSR24 LED strips connector system

PHOTO	Art No.	Description
	F080AC	Supply Lead <ul style="list-style-type: none"> 8mm strip cable connector 24V/3A end tin 22AWG/2C white
	F080AS	Connector <ul style="list-style-type: none"> 8mm strip to strip connector LV SSR24 24V/3A white
 NEW	F080BC	Supply Lead <ul style="list-style-type: none"> 8mm strip cable connector 24V/3A end tin 22AWG/2C white
 NEW	F080BS	Connector <ul style="list-style-type: none"> 8mm strip to strip connector LV SSR24 24V/3A white
	F100AC	Supply Lead <ul style="list-style-type: none"> 10mm strip cable connector 24V/3A end tin 22AWG/2C white
	F100AS	Connector <ul style="list-style-type: none"> 10mm strip to strip connector 24V/3A white
	F100RC	Supply Lead <ul style="list-style-type: none"> 10mm RGB strip cable connector 24V/3A end tin 22AWG/4C white
	F100RS	Connector <ul style="list-style-type: none"> 10mm RGB strip to strip connector 24V/3A white

LV SSR24

DC Connector System

- Connection: Max.7A/6-30V
- Cable: Max.18AWG



DC Connector

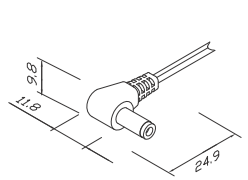
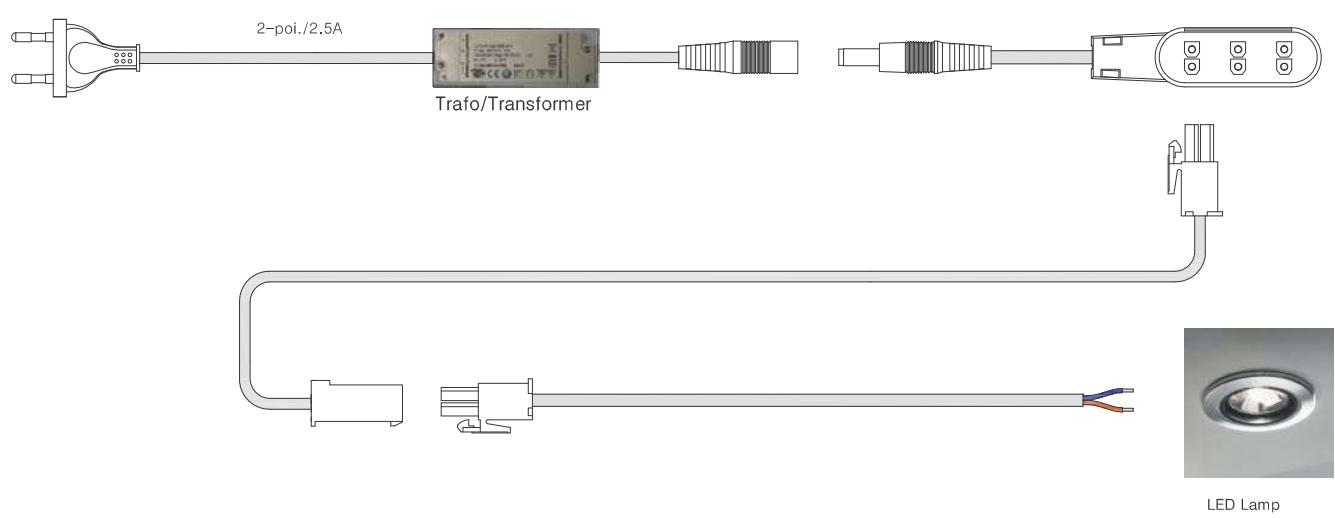

Description: 5521 male plug
Art No: L828R

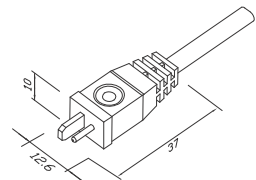

Description: 01 Male plug
Art No: L832

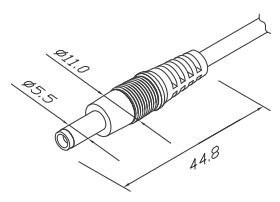

Description: 5521 male plug
Art No: L828

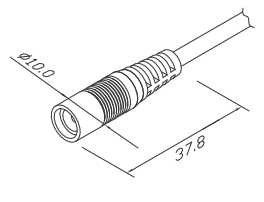

Description: 5521 female socket
Art No: L829

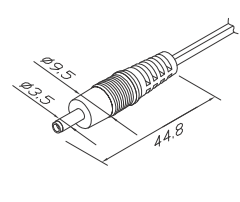

Description: male plug
Art No: L828 1.3x3.5

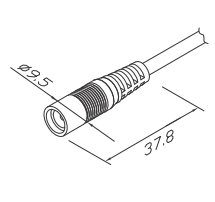

Description: female socket
Art No: L829 1.3x3.5

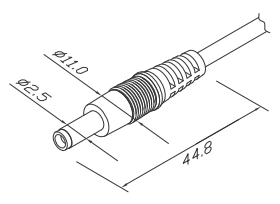

Description: 5525 male plug
Art No: L830

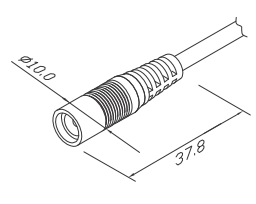

Description: 5525 female socket
Art No: L831

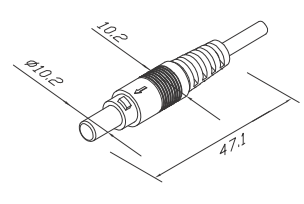

Description: 5521 male plug
Art No: L828P

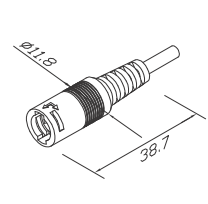

Description: 5521 female socket
Art No: L829P

30V/7A DC connector system

PHOTO	Art No.	Description
	L828P	<p>Supply Lead</p> <ul style="list-style-type: none"> ■ 5521 Male plug ■ 30V/7A ■ end tin ■ 18AWG/2C ■ white
	L829P	<p>Supply Lead</p> <ul style="list-style-type: none"> ■ 5521 Male plug ■ 30V/7A ■ terminal ends ■ 18AWG/2C ■ white
	L828	<p>Supply Lead</p> <ul style="list-style-type: none"> ■ 5521 Male plug ■ 30V/7A ■ end tin ■ 18AWG/2C ■ white
	L828R	<p>Supply Lead</p> <ul style="list-style-type: none"> ■ 5521 Male plug ■ 30V/3.5A ■ end tin ■ 22AWG/2C ■ white
	L829	<p>Supply Lead</p> <ul style="list-style-type: none"> ■ 5521 Male plug ■ 30V/7A ■ terminal ends ■ 18AWG/2C ■ white
	L830	<p>Supply Lead</p> <ul style="list-style-type: none"> ■ 01 Male plug ■ 30V/3.5A ■ end tin ■ 22AWG/2C ■ white



Mini AMP 6way with ceiling light



Mini AMP 6way with cabinet light



Mini AMP 3way with cabinet light



LV806 4way cabinet light



Mini AMP 3way with ceiling light



Lv806 4way kitchen light



Mini AMP 6way with ceiling light



Mini AMP 6way with ceiling light



HVL760 250V with T5 lamp+24V ceiling light



HVL760 250V with T5 lamp+LV806 6way with furniture light



HVL760 250V 2way+Mini AMP 6way with ceiling light



HVL760 250V 2way+Mini AMP connector with ceiling light



HVL760 24V 6way with ceiling light



HVL760 24V 6way with kitchen light

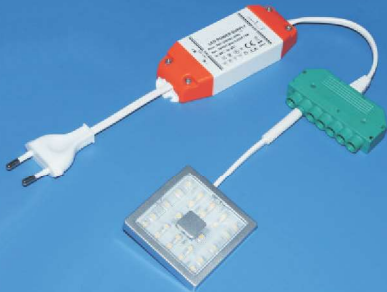

HVL760 24V 6way with cabinet light



HVL760 250V with T5 lamp+24V 6way furniture light



HVL760 250V connector+50V 2way with ceiling light



HVL760 250V 2way+50V 2way with ceiling light



HVL760 250V 6way+50V 2way with ceiling light



HVL760+24V with ceiling light



HVL760 50V 2way with ceiling light



MX24 6way+DC5521 Socket



JST24 6way+DC5521 Socket



Mini AMP 6way+315switch



Mini AMP++LED Mini Plug



LV806 6way distributor



Mini AMP+DC5521 Socket



Mini AMP 3way+Mini AMP Plug



Mini AMP 6way+DC5521Plug



01 Plug+315switch



LED Mini Y-distributor



G5.3/GX5.3/G6.35+DC5521 Socket



LED Mini Socket+DC5521 Socket



Mini AMP Y-distributor+DC5521 Socket



RGB Strip Extension Lead



LED Mini Plug+DC350 Plug

Contact

Hong Kong Company:

AQL Technology Limited

Room 1501, 15/F, SPA Centre, 53-55 Lockhart Road, Wanchai, Hong Kong

China Mainland Company:

Shenzhen Aiqli Lighting Technologg Limited (深圳艾奇力照明科技有限公司)

6F,Building 335,Yucuixincun, Longhua New District,Shenzhen,China

Telephone: +86 755 215 05 499

After work time: + 86 157 662 65 817

Warehouse

1F of the No.2 Warehouse, Xiangzhao Logistics Park,Bujiuwo,Fulong Road,Longhua New

Turkey Company:

AQL Teknoloji Aydınlatma İthalat İhracat San. Ve Tic. Ltd. Şti.

İstanbul City

Aydıntepe mah. Beydağı cad. No:5

Tuzla EVORA Evleri B5 Blok Kat:5 No.45

Tuzla **İSTANBUL TURKEY**

Telephone: +90 216 909 45 62

Mobile: +90 533 455 63 18

Bursa City

Zekai Gümüşdiş Mah. G.O.P. Cad. No:41/2

Osmangazi **BURSA TURKEY**

Skype:

Asli.wei

Email:

info@aqltechno.com

web:

www.aqltechno.com

